

Alarm Controller v1.1 Installation Guide

This installation guide provides the basic wiring, programming and troubleshooting information required to install the PowerSeries Neo alarm controller. *Use this guide in conjunction with the PowerSeries Neo Reference Manual available online from the DSC website at www.dsc.com.* Available models: HS2016, HS2032, HS2064, HS2128.

Quick Setup

| | | |
|----------|--------------------------------|---|
| 1 | Plan | Plan the installation including all alarm detection devices, zone expanders, keypads and other required modules. |
| 2 | Mount | Decide on a location for the alarm panel and secure it to the wall using suitable mounting hardware. |
| 3 | Wire | Complete all wiring including modules, zones, bells/sirens, telephone line connections and ground connections. Record module serial numbers on page 20. |
| 4 | Power | Connect the battery and power up the system. The battery must be connected. |
| 5 | Enroll First Keypad | Hardwired: Wire the keypad to the Corbus, power up the alarm panel then press any button on the keypad. Wireless: Wire the HSM2Host to the Corbus, then power up the alarm panel and a wireless keypad. Press any button on the keypad to enroll it. The HSM2Host is then enrolled on the alarm panel. Alternately, enroll an RF keypad. |
| 6 | Enroll modules | [*][8][Installer Code][902] subsection [000]. Press [*] to begin auto-enrollment. Module slots are automatically assigned. Use scroll keys to view slots. Change slot by typing a 2-digit number. |
| 7 | Enroll wireless devices | [*][8][Installer Code][804] subsection [000]. Note: An HSM2HOST or RF keypad must be enrolled first. |
| 8 | Program | Basic programming: [*][8][installer code] [001]/[002]> Zone Type/Zone Attribute [005]>[001] Partition 1 Timers: – Entry Delay 1 – Entry Delay 2 – Exit Delay [301]>[001] Phone #1 [310]>[000] System Account Code |
| 9 | Test | Test the panel completely to ensure that all features and functions operate as programmed. – [901] Walk Test – [904][000] Wireless Placement Test |

Note: For ULC-s559 Listed applications the HS2TCHP touch screen keypad is for supplementary use only.

| | | |
|------------------------------------|--|--|
| 2-way wireless integration module: | HSM2HOSTx ^{UL} | |
| 8-zone expander: | HSM2108 ^{UL} | |
| 8-output expander: | HSM2208 ^{UL} | |
| Power supply: | HSM2300 ^{UL} | |
| 4 high current output expander: | HSM2204 ^{UL} | |
| Alternate communicator: | 3G2080 ^{UL} 3G2080R ^{UL} TL280 ^{UL} TL280R ^{UL} | TL2803G ^{UL} TL2803GR ^{UL} PCL-422 ^{UL} |

Hardwired Devices

| | | |
|-------------------------|---|--|
| 2-wire smoke detectors: | FSA-210x ^{UL} FSA-210xT ^{UL} FSA-210xS ^{UL} FSA-210xST ^{UL} FSA-210xLST ^{UL} | FSA-210xR ^{UL} FSA-210xRT ^{UL} FSA-210xRS ^{UL} FSA-210xRST ^{UL} FSA-210xLRST ^{UL} |
| 4-wire smoke detectors: | FSA-410x ^{UL} FSA-410xT ^{UL} FSA-410xS ^{UL} FSA-410xST ^{UL} FSA-410xLST ^{UL} | FSA-410xR ^{UL} FSA-410xRT ^{UL} FSA-410xRS ^{UL} FSA-410xRST ^{UL} FSA-410xLRST ^{UL} |
| CO detectors: | CO-12/24 ^{UL} 12-24SIR ^{UL} FW-CO12 ^{UL} | FW-CO1224 ^{UL} CO1224 ^{UL} |

Wireless Devices

| | |
|--|--|
| Wireless PG smoke detectors | PGx926 ^{UL} |
| Wireless PG smoke and heat detector | PGx916 ^{UL} |
| Wireless PG CO detector: | PGx916 ^{UL} |
| Wireless PG PIR motion detectors: | PGx904(P) ^{UL} |
| Wireless PG PIR + camera motion detector | PGx934(P) ^{UL} |
| Wireless PG curtain motion detector | PGx924 ^{UL} |
| Wireless PG dual tech motion detector | PGx984(P) |
| Wireless PG mirror motion detector | PGx974(P) ^{UL} |
| Wireless PG outdoor motion detector | PGx994 ^{UL} |
| Wireless PG glass break detector: | PGx912 |
| Wireless PG shock detector: | PGx935 ^{UL} |
| Wireless PG flood detector: | PGx985 ^{UL} |
| Wireless PG temperature detector (indoor use): | PGx905 ^{UL} |
| Outdoor temperature probe (requires PGx905) | PGTEMP-PROBE |
| Wireless PG keys: | PGx939 ^{UL} PGx929 ^{UL} |
| Wireless PG panic key | PGx938 ^{UL} |
| Wireless PG 2-button key | PGx949 ^{UL} |
| Wireless PG sirens: | PGx901 ^{UL} PGx911 ^{UL} |
| Wireless PG repeater: | PGx920 ^{UL} |
| Wireless PG door/window contacts: | PGx975 ^{UL} |
| Wireless PG door/window contact w/ AUX | PGx945 ^{UL} |

Central Station Receivers

SG-System I, II, III, IV

Enclosures

PC5003C, PC4050CR (ULC Fire Monitoring), PC4050CAR (UL Commercial Burg), CMC-1(UL Commercial Burg) Other enclosures are available to suit a variety of system configurations.

Compatible Devices

Throughout this document, x in the model number represents the operating frequency of the device as follows: 9 (912-919 MHz), 8 (868MHz), 4 (433MHz).

Note: Only models operating in the band 912-919 MHz are UL/ULC listed where indicated. Only ^{UL} approved devices are to be used with UL/ULC listed systems.

Table 1-1 Compatible Devices

Modules

| | | |
|---|---|---|
| Wireless keypads: | HS2LCDWFx ^{UL} HS2LCDWFPx ^{UL} | HS2LCDWFPVx ^{UL} |
| Hardwired keypads with 2-way wireless integration module: | HS2LCDRFx ^{UL} HS2LCDRFPx ^{UL} | HS2ICNRFx ^{UL} HS2ICNRFPx ^{UL} |
| Hardwired keypads: | HS2LCD ^{UL} HS2LCDP ^{UL} HS2ICN ^{UL} | HS2ICNP ^{UL} HS2LED ^{UL} |
| Touchscreen Keypad | HS2TCHP | |



WARNING: This manual contains information on limitations regarding product use and function and information on the limitations as to liability of the manufacturer. The entire manual should be carefully read.

Safety Instructions for Service Personnel

Warning: When using equipment connected to the telephone network, always follow the basic safety instructions provided with this product. Save these instructions for future reference. Inform the end-user of the safety precautions that must be observed when operating this equipment.

Before Installing The Equipment

Ensure your package includes the following items:

- Installation and User manuals, including the SAFETY INSTRUCTIONS. READ and SAVE these instructions!
- Follow all WARNINGS AND INSTRUCTIONS specified within this document and/or on the equipment.
- HS2016/HS2016/2032/2064/2128 alarm controller
- Power Supply, direct plug-in
- Mounting hardware

Selecting A Suitable Location For The Alarm Controller

Use the following list as a guide to find a suitable location to install this equipment:

- Locate near a telephone socket and power outlet.
- Select a location free from vibration and shock.
- Place alarm controller on a flat, stable surface and follow the installation instructions.
- Do NOT locate this product where people may walk on the secondary circuit cable(s).
- Do NOT connect alarm controller to electrical the same circuit as large appliances.
- Do NOT select a location that exposes your alarm controller to direct sunlight, excessive heat, moisture, vapors, chemicals or dust.
- Do NOT install this equipment near water. (e.g., bath tub, kitchen/laundry sink, wet basement, near a swimming pool).
- Do NOT install this equipment and accessories in areas where risk of explosion exists.
- Do NOT connect this equipment to electrical outlets controlled by wall switches or automatic timers.

AVOID interference sources.
 AVOID installing equipment near heaters, air conditioners, ventilators, and refrigerators.
 AVOID locating equipment close to or on top of large metal objects (e.g., wall studs).

See "Locating Detectors and Escape Plan" on page 24 for information on locating smoke and CO detectors.

SAFETY Precautions Required During Installation

- NEVER install this equipment and/or telephone wiring during a lightning storm.
- NEVER touch uninsulated telephone wires or terminals unless the telephone line has been disconnected at the network interface.
- Position cables so that accidents can not occur. Connected cables must NOT be subject to excessive mechanical strain.
- Use only the power supply provided with this equipment. Use of unauthorized power supplies may cause damage.
- For direct plug-in versions, use the transformer supplied with the device.

WARNING: THIS EQUIPMENT HAS NO MAINS ON/OFF SWITCH. THE PLUG OF THE DIRECT PLUG-IN POWER SUPPLY IS INTENDED TO SERVE AS THE DISCONNECTING DEVICE IF THE EQUIPMENT MUST BE QUICKLY DISCONNECTED. IT IS IMPERATIVE THAT ACCESS TO THE MAINS PLUG AND ASSOCIATED MAINS SOCKET/OUTLET IS NEVER OBSTRUCTED.

IMPORTANT NOTE FOR NORTH AMERICA!

This alarm system must be installed and used within an environment that provides the pollution degree max 2 and over-voltages category II NON- HAZARDOUS LOCATIONS, indoor only. The equipment is DIRECT PLUG-IN (external transformer) and is designed to be installed, serviced and/or repaired by service persons only; [service person is defined as a person having the appropriate technical training and experience necessary to be aware of hazards to which that person may be exposed in performing a task and of measures to minimize the risks to that person or other persons]. This equipment has no mains on/off switch; if the equipment must be quickly disconnected, the plug of the direct plug-in power supply is intended to serve as the disconnecting device; it is imperative that access to the mains plug and associated mains socket/outlet, is never obstructed. There are no parts replaceable by the end-user within this equipment. The wiring (cables) used for installation of the alarm system and accessories, shall be insulated with PVC, TFE, PTFE, FEP, Neoprene or Polyamide.

- The equipment enclosure must be secured to the building structure before operation.
- Internal wiring must be routed in a manner that prevents:

- Excessive strain or loosening of wire on terminal connections;
- Damage of conductor insulation
- (c) Disposal of used batteries must be made in accordance with local waste recovery and recycling regulations.
- (d) Before servicing, DISCONNECT the power and telephone connection.
- (e) DO NOT route any wiring over circuit boards.
- (f) The installer is responsible to ensure that a readily accessible disconnect device is incorporated in the building for permanently connected installations.

The power supply must be Class II, FAIL SAFE with double or reinforced insulation between the PRIMARY and SECONDARY CIRCUIT/ENCLOSURE and be an approved type acceptable to the local authorities. All national wiring rules must be observed.

Installation

Mounting the Enclosure

Locate the panel in a dry area, preferably near an unswitched AC power source and the incoming telephone line. Complete all wiring before applying AC or connecting the battery.

Terminal Descriptions

The following terminals are available on the PowerSeries Neo alarm controller.

| Terminal | Description |
|------------------------|--|
| BAT+, BAT- | Battery terminals. Use to provide backup power and additional current when system demands exceed the power output of the transformer, such as when the system is in alarm. Do not connect the battery until all other wiring is complete. |
| AC | Power terminals. Connect the battery before connecting the AC. Do not connect the battery or transformer until all other wiring is complete. |
| AUX+, AUX- | Auxiliary terminals. Use to power modules, detectors, relays, LEDs, etc. (700mA MAX). Connect the positive side of device to AUX+, the negative side to AUX-. |
| BELL+, BELL- | Bell/Siren power. Connect the positive side of any alarm warning device to BELL+, the negative side to BELL-. |
| RED, BLK, YEL, GRN | Corbus terminals. Use to provide communication between the alarm controller and connected modules. Each module has four Corbus terminals that must be connected to the Corbus. |
| PGM1 to PGM4 | Programmable output terminals. Use to activate devices such as LEDs. (PGM1, PGM3, and PGM4: 50mA PGM2: 300mA or can be configured as an input) |
| Z1 to Z8 COM | Zone input terminals. Ideally, each zone should have one detection device; however, multiple detection devices can be wired to the same zone. |
| EGND | Earth ground connection. |
| TIP, RING, T-1, R-1 | Telephone line terminals. |
| PCLINK_1 | DLS/SA |
| PCLINK_2 | DLS/SA, Alternate Communicator |

Corbus Wiring

The RED and BLK Corbus terminals are used to provide power while YEL and GRN are used for data communications. The 4 Corbus terminals of the alarm controller must be connected to the 4 Corbus terminals or wires of each module.

The following conditions apply:

- Corbus should be run with minimum 22 gauge quad, two pair twisted preferred.
- The modules can be home run to the panel, connected in series or can be T-tapped.
- Do not use shielded wire for Corbus wiring.

Note: Any module can be connected anywhere along the Corbus. Separate wire runs for keypads, zone expanders etc. are not necessary.

Note: No module can be more than 1,000'/305m (in wire length) from the panel. Do not use shielded wire for Corbus wiring.

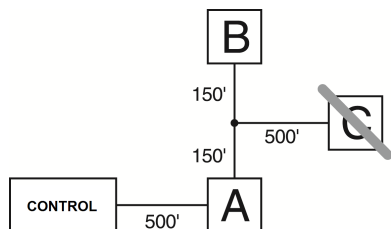

Figure 1-1 Corbus Wiring

Module (A) is wired correctly as it is within 1,000'/305m of the panel, in wire distance. Module (B) is wired correctly as it is within 1,000'/305m of the panel, in wire distance. Module (C) is NOT wired correctly as it is farther than 1,000'/305m from the panel.

Current Ratings

In order for the system to operate properly, the power output of the alarm controller and power supply modules cannot be exceeded. Use the following data to ensure that the available current is not exceeded.

Table 1-1 System Output Ratings

| Device | Output | Rating (12Vdc) |
|--------------------------------------|--------|---|
| HS2016 HS2032 HS2064 HS2128 | AUX: | 700mA. Subtract the listed rating for each keypad, expansion module and accessory connected to AUX or Corbus. At least 100mA must be reserved for the Corbus. |
| | BELL: | 700mA. Continuous rating. 2.0A. short term. Available only with standby battery connected. Not for UL/ULC or EN certified applications. |
| HSM2208 | AUX: | 250mA. Continuous rating. Subtract for each device connected. Subtract the total load on this terminal from the alarm panel AUX/Corbus output. |
| HSM2108 | AUX: | 100mA. Subtract for each device connected. Subtract the total load on this terminal from the panel AUX/Corbus output. |

Alarm Control Panel

AUX - 700mA available for devices connected to the AUX and PGM terminals, and modules connected to Corbus terminals. At least 100mA must be reserved for the Corbus.

Alarm Controller Current Calculation

Panel Calculation

Maximum (Standby or Alarm)

AUX (700mA max. including PGMs 1-4)

Corbus (700mA max.)***

PCLink+ (Alt. Com.:125mA)

Total (must not exceed 700mA)

*** See "Corbus Current Calculation Chart" on page 3.

For UL, ULC and Commercial Listed applications, the total standby and alarm current cannot exceed 700mA.

Table 1-2 Corbus Current Calculation Chart

| Item | Current (mA) | x | Quantity | Total (mA) |
|--|--------------|---|----------|------------|
| HS2016/HS2032 /HS2064/HS2128 | 85 | X | 1 | 85 |
| HS2LCD | 105 | x | | |
| HS2ICN | 105 | x | | |
| HS2LED | 105 | x | | |
| HS2LCDP | 105 | x | | |
| HS2ICNP | 105 | x | | |
| HS2LCDRF | 105 | x | | |
| HS2ICNRF | 105 | x | | |
| HS2ICNRFP | 105 | x | | |
| HS2TCHP | 160 | x | | |
| Current required for connected devices = | | | | |
| HSM2108* | 30 | x | | |
| AUX output current of HSM2108 | | | | |
| HSM2208* | 40 | x | | |
| AUX output current of HSM2208 | | | | |
| HSM2300/2204* | 35 | x | | |
| HSM2HOSTx | 35 | x | | |
| HSM2955** | | x | | |
| 3G208(R)/TL2803G(R)/TL280 (R) | 125 (PCLINK) | x | | |
| Total Corbus Current = | | | | |

*These units draw current from the Corbus to power devices external to the module. This current must be added to the total Corbus current. See manufacturer's specifications for the current draw of each device.

** For HSM2955 current draw refer to HSM2955 installation manual.

Capacitance Limits

An increase in capacitance on the Corbus affects data transmission and causes the system to slow down. Capacitance increases for every foot of wire added to the Corbus. The capacitance rating of the wire used will determine the maximum length of the Corbus.

Table 1-3 Wire Capacitance

| Wire Capacitance per 1000' (300m) | Total Corbus Wire Length |
|-----------------------------------|--------------------------|
| 15nF | 5300'/1616m |
| 20nF | 4000'/1220m |
| 25nF | 3200'/976m |
| 30nF | 2666'/810m |
| 35nF | 2280'/693m |
| 40nF | 2000'/608m |

AC (UL Listed Installations)

Primary: 120VAC/60Hz/0.33A

Secondary: 16.5VAC/40VA DSC PTD1640U, DSC PTC1640U Class 2 transformer.

Note: Use DSC PTD1640 for Canadian installations.

Warning: Do not connect the battery or transformer until all other wiring is complete.

For ULC S559 applications, Standex transformer (Model FTC3716) shall be employed for direct-wiring.

Note: For UL/ULC installations use only 60Hz.

Batteries

Do not connect the battery until all other wiring is complete.

Note: A sealed, rechargeable, lead acid battery or gel type battery is required to meet UL requirements for power standby times.

Connect the RED battery lead to the positive battery terminal and the BLACK battery lead to the negative battery terminal.

Note: Refer to "Aux Loading and Battery Selection" on page 21.

Additional Wiring

Zone Wiring

Power down the alarm controller and complete all zone wiring.

Zones can be wired to supervise normally open devices (e.g., smoke detectors) or normally closed devices (e.g., door contacts). The alarm panel can also be programmed for single end-of-line or double end-of-line resistors.

Zone programming is done using the following programming sections:

- [001] selects zone definition
- [013] Opt [1] for normally closed or EOL; Opt [2] for SEOL or DEOL

Observe the following guidelines when wiring zones:

- For UL listed installations use SEOL or DEOL only
- Minimum 22 AWG wire, maximum 18 AWG
- Do not use shielded wire
- Do not exceed 100Ω wire resistance. Refer to the table below:

Table 1-4 Burglary Zone Wiring Chart

| Wire Gauge | Maximum Length to EOL Resistor (ft/-meters) |
|------------|---|
| 22 | 3000 / 914 |

| Wire Gauge | Maximum Length to EOL Resistor (ft/-meters) |
|------------|---|
| 20 | 4900 / 1493 |
| 19 | 6200 / 1889 |
| 18 | 7800 / 2377 |

Figures are based on maximum wiring resistance of 100Ω.

Aux Power Wiring

These terminals provide 11.3-12.5VDC/700mA of current (shared with PGM outputs). Connect the positive side of any device to the AUX+ terminal, the negative side to GND. The AUX output is protected; if too much current is drawn from these terminals (wiring short) the output is temporarily shut off until the problem is corrected.

Note: If using a 12V, 14Ah battery, maximum AUX capacity for 24-hour standby is 470mA.

PGM Wiring

Min/max operating voltages for devices, sensors and modules is 9.5VDC - 14VDC.

PGMs switch to ground when activated from the alarm controller. Connect the positive side of the device to the AUX+ terminal and the negative side to a PGM terminal.

PGM 1, 3, 4 supply up to 50mA; PGM 2 supplies up to 300mA.

A relay is required for current levels greater than 50mA or 300mA. PGM2 can also be used for 2-wire smoke detectors.

Note: Use SEOL resistors on Fire zones only.

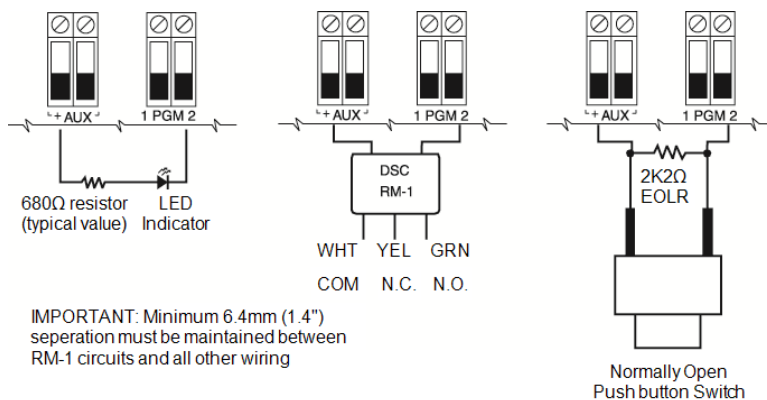

Figure 1-2 LED Output with Current Limiting Resistor and Optional Relay Driver Output.

UL Compatibility ID For FSA-210B Series is: FS200

Note: For ULC listed installations, use FSA-210A and FSA-410A series.

Single End-of-Line (SEOL) Resistor

When SEOL resistors are installed at the end of a zone loop, the alarm panel detects if the circuit is secure, open, or shorted. The SEOL resistor must be installed at the end of the loop for proper supervision.

To enable SEOL supervision, program section [013], options [1] and [2] to OFF.

Note: This option should be selected if either normally closed or normally open detection devices or contacts are used.

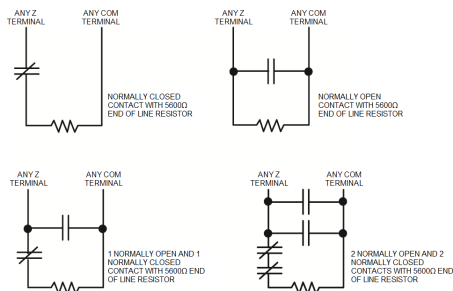

Figure 1-3 SEOL Wiring

Double End of Line (DEOL) Resistors

When double end-of-line (DEOL) resistors are installed at the end of a zone loop, the second resistor enables the panel to determine if the zone is in open, closed, tampered or faulted.

Note: Any zone programmed for Fire or 24-hr Supervisory must be wired with a SEOL resistor regardless of the type of zone wiring supervision selected for the panel. If you change the zone supervision options from DEOL to SEOL or from NC to DEOL, power the system down completely, then power it back up for correct operation.

To enable DEOL supervision, program section [013], option [1] to OFF and option [2] to ON.

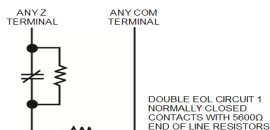

Figure 1-4 DEOL Wiring

Bell Wiring

These terminals supply 700mA of current at 10.4 - 12.5VDC for commercial/ residential installations. To comply with NFPA 72 Temporal Three Pattern requirements, section [013] Opt [8] must be ON. Note that steady, pulsed alarms are also supported.



Figure 1-5 Bell Wiring

The Bell output is supervised and power limited by 2A PTC. If unused, connect a 1000Ω resistor across Bell+ and Bell- to prevent the panel from displaying a trouble.

Telephone Line Wiring

Wire the telephone connection terminals (TIP, Ring, T-1, R-1) to an RJ-31x connector as indicated in the following diagram. For connection of multiple devices to the telephone line, wire in the sequence indicated. Use 26 AWG wire minimum for wiring.

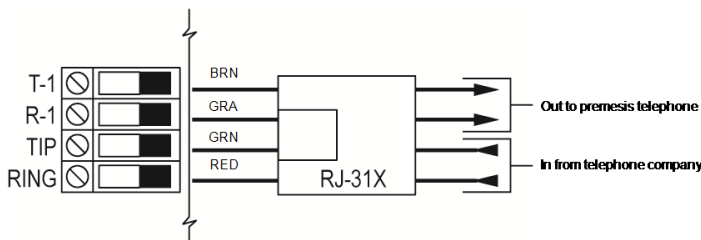

Figure 1-6 Telephone Line Wiring

Telephone format is programmed in option [350]. Telephone call directions are programmed in options [311]- [318].

Ground Wiring

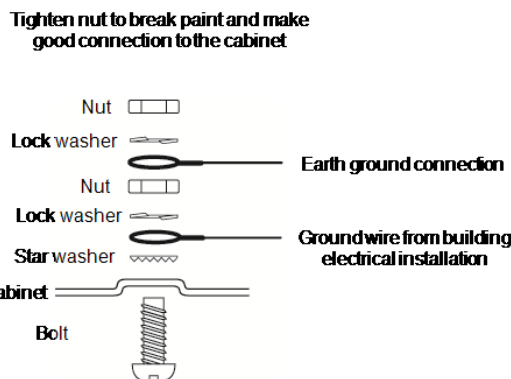

Figure 1-7 Ground Installation

Note: Using an insulated green wire (minimum 22AWG), connect the EGND terminal on the Corbus and the grounding wire from the building electrical installation to any of the available holes on the back or side of the metal cabinet. See the diagram attached to the cabinet for suggested GND point location and hardware recommendations.

Note: Wire and installation hardware not included.

Enrollment

All optional modules and devices must be enrolled on the system. During enrollment, the electronic serial number (ESN) of each device is identified to the control panel and zones are assigned. A wireless transceiver HSM2HOST or an RF keypad must be enrolled first before wireless devices can be enrolled.

Enrolling Modules

During automatic and manual enrollment, if an attempt is made to enroll more than the maximum number of modules, an error tone sounds and a message is displayed on LCD keypads.

Table 1-5 Module Capacity

| Module | HS2016 | HS2032 | HS2064 | HS2128 |
|---|--------|--------|--------|--------|
| HSM2108 8 Zone expander | 1 | 3 | 7 | 15 |
| HSM2208 8 Output expander | 2 | 4 | 8 | 16 |
| Wireless Keypad: HS2LCDRF(P)4 HS2ICNRF(P)4 HS2LCDWF(P)(V)4 | 8 | 8 | 8 | 16 |
| HS2TCHP Touchscreen Keypad | 8 | 8 | 8 | 16 |
| HSM2300 Power Supply 1A | 3 | 3 | 3 | 4 |
| HSM2204 4 High-current Output | 1 | 1 | 3 | 4 |
| HSM2HOSTx Transceiver | 1 | 1 | 1 | 1 |
| HSM2955 (not UL evaluated) | 1 | 1 | 1 | 1 |

Modules can be enrolled automatically or manually using section [902] of Installer programming.

To confirm that a module has been successfully enrolled, use Installer Programming section [903].

Enroll Wireless Devices

Wireless devices are enrolled via the wireless transceiver module and Installer Programming section [804][000].

Auto Enrollment

To enroll a wireless device using this method, press and hold the Enroll button on the device for 2-5 seconds until the LED lights then release the button. The alarm panel automatically recognizes the device and the keypad displays a confirmation message. The device ID and next available zone number are displayed. Press [*] to accept or scroll to another available zone number. Batteries must be installed in the wireless device in order to enroll.

Pre-Enrollment

Pre-enrollment is a two step process. The first step requires entering each device ID ([804][001]-[716]). Every wireless device has an ID printed on the sticker attached to the device. The format is XXX-YYYY where:

- XXX identifies the type or model of the device
- YYYY is a short encrypted ID used by the system to identify the specific device

Pre-enrollment can be done at a remote location and using DLS/SA. The second step is to press the enrollment button on the device, usually done on location. Installer Programming does not have to be entered at this step. Both steps must be performed in order to complete the enrollment.

Programming Methods

The alarm system can be programmed using the following methods:

Table 1-6 Programming Methods

| Method | Description | Procedure |
|-----------------------|---|---|
| Template programming | Use pre-defined templates to quickly apply basic programming and to set up DLS downloading. | Press [899] at the "Enter Section" screen. See Template Programming below for details. |
| DLS programming | Download and apply programming using DLS 5 v1.3 for Neo v1.0 panels and DLS 5 v1.4+ for Neo v1.0 and v1.1 products. | For local DLS, use a PC-Link cable and laptop with DLS-V software installed. For remote DLS, use a telephone line, cellular network or the Internet. |
| Installer programming | Manually program all alarm system and device options. | Press [*][8][installer code] while the system is disarmed. |

Viewing Programming

Programming sections can be viewed from any system keypad. The method for viewing and selecting programming options using LCD, LED and ICON keypads depends on the keypad type used. See below for specific instructions on programming with each keypad type.

Generally, programming options are accessed in the following way:

1. Enter Installer Programming mode ([*][8]).
2. Navigate to a specific programming section.
3. Select an option to view or change its programming.

All programming options are numbered and can be accessed by navigating through the menu (LCD) or by keying in the program section number. For

toggle options, the name of the option is displayed (LCD) or LEDs 1-8 are illuminated (LED and ICON).

Use the keypad numbers to toggle options on or off. Sections requiring data input, such as phone numbers, display the full data in fields up to 32 characters long (LCD). To input data, use the scroll keys to select a character then press the keypad button corresponding to the number/letter required. Scroll to the next character and repeat the procedure as needed. Press the [#] key to save changes and exit the program section.

Minimum Required Programming

Once basic installation of the alarm panel is complete, the following general configuration options can be set.

[000] Language Selection

(LCD keypads only)

Use this section to set the language displayed by LCD keypads. To select a language:

1. Enter Installer Programming: [*][8][Installer Code].
2. Enter programming section [000]>[000].
3. Key in the 2-digit number corresponding to the language required. See below:

| | | |
|-----------------|----------------|-----------------|
| 01 = English | 11 = Swedish | 22 = Bulgarian |
| 02 = Spanish | 12 = Norwegian | 23 = Latvian |
| 03 = Portuguese | 13 = Danish | 24 = Lithuanian |
| 04 = French | 14 = Hebrew | 25 = Ukrainian |
| 05 = Italian | 15 = Greek | 26 = Slovakian |
| 06 = Dutch | 16 = Turkish | 27 = Serbian |
| 07 = Polish | 18 = Croatian | 28 = Estonian |
| 08 = Czech | 19 = Hungarian | 29 = Slovenian |
| 09 = Finnish | 20 = Romanian | |
| 10 = German | 21 = Russian | |

Time and Date

Use this section to program the alarm system clock.

Menu: [*][6][Master Code] > Time and Date

Keypad: [*][6][Master Code] + 01

Enter time and date using the following format: (HH:MM); (MM-DD-YY). Valid time entries are 00-23hours, 00-59 minutes. Valid date entries are 1-12 months, 1-31 days.

Setting Up a Partition

Partitions are added or removed from the system by applying or removing a partition mask via Installer Programming section [200]. The number of available partitions depends on the alarm panel model.

Bell/Siren Operation

Each partition must have a siren. The system siren connected to the bell output of the alarm controller can be mounted in a central location within hearing range of all partitions. Each partition can also have wireless sirens activated only on the assigned partition.

Keypad Partition Setup

Keypads can be configured to control an individual partition or all partitions. In general, a partition keypad controls the partition it is assigned to. A Global keypad controls all partitions. Global keypads should be placed in common areas of the premises, such as points of entry or reception areas, where the ability to arm and disarm more than one partition at a time is required.

Partition keypads can also be temporarily loaned to other partitions.

To select a keypad operating mode:

1. Enter Installer Programming: [*][8][installer code].
2. Select [861]-[876] to program keypads 1-16.
 - Press [000] for partition assignment.
 - For Global operation, key in 00.
 - To assign a keypad to a partition, key in 01-08 for partition 1-8.
3. Press the [#] and repeat step 2 for next keypad. When finished programming all keypads, press the [#] key twice to exit programming.

Users are assigned partition access rights via the [*][5] menu.

Assign sirens to partitions:

[804]>[000]>[551]-[556]>[000]

Set up partition account codes:

[310]>[001]-[008]

Set up partition timers:

- Entry/exit delay, settle delay – [005]>[001]-[008]
- Automatic arming/disarming schedule – [151]-[158]>[001]/[002]
- Auto disarming holiday schedule – [151]-[158]>[003]
- No activity arming – [151]-[158]>[006]
- Automatic clock adjust – [005]>[000], option 6
- Delay between dialing attempts – [377]>[012]

Assign Zone Types

A zone type defines how a zone operates within the system and how it responds when triggered.

| | |
|----------------------------------|-----------------------------------|
| 000 - Null Zone | 040 - 24-Hour Gas |
| 001 - Delay 1 | 041 - 24-Hour CO |
| 002 - Delay 2 | 042 - 24-Hour Holdup* |
| 003 - Instant | 043 - 24-Hour Panic |
| 004 - Interior | 045 - 24-Hour Heat |
| 005 - Interior Stay/Away | 046 - 24-Hour Medical* |
| 006 - Delay Stay/Away | 047 - 24-Hour Emergency |
| 007 - Delayed 24-Hour Fire | 048 - 24-Hour Sprinkler* |
| 008 - Standard 24-Hour Fire | 049 - 24-Hour Flood |
| 009 - Instant Stay/Away | 051 - 24-Hour Latching Tamper |
| 010 - Interior Delay | 052 - 24-Hour Non-Alarm |
| 011 - Day Zone | 056 - 24-Hour High Temperature |
| 012 - Night Zone | 057 - 24 Hour Low Temperature |
| 016 - Final Door Set | 060 - 24-Hour Non-Latching Tamper |
| 017 - 24-Hour Burglary | 066 - Momentary Keyswitch Arm |
| 018 - 24-Hour Bell/Buzzer | 067 - Maintained Keyswitch Arm |
| 023 - 24-Hour Supervisory | 068 - Momentary Keyswitch Disarm |
| 024 - 24-Hour Supervisory Buzzer | 069 - Maintained Keyswitch Disarm |
| 025 - Auto Verified Fire | 071 - Door Bell |
| 027 - Fire Supervisory | 072 - Push to Set |
| | * Not UL evaluated |

Assign zone attributes:

[002]>[001]-[128]>Select one of the following zone attributes:

- 1 – Bell Audible
- 2 – Bell Steady
- 3 – Chime Function
- 4 – Bypass Enabled
- 5 – Force Arm
- 6 – Swinger Shutdown
- 7 – Transmission Delay

- 8 – Burglary Verification
- 9 – Normally Closed EOL
- 10 – Single EOL
- 11 – Double EOL
- 12 – Fast/Normal Loop Response
- 13 – Zone 2-way Audio Activation
- 14 – Hold Up Verification

Create labels:

[000]>[001]-[821] 2 x 14 ASCII characters.

Add access codes:

To program an access code: [006] then one of the following:

- [001] – Installer code
- [002] – Master code
- [003] – Maintenance code

Access codes are either 4 or 6 digits in length, depending on the setting of programming section [041]. Duplicate codes are not valid.

Alternate Communicator Setup

The alternate communicator is an optional wireless communications device that can be used as a backup to the PSTN connection or as a primary means of communication between the alarm panel and the central monitoring station. The alternate communicator communicates via 3G (HSPA) or Ethernet.

The following configuration steps are required to set up the alternate communicator:

- Install the alternate communicator and wire it to the alarm panel (use PCLINK_2 header)
- Enroll the alternate communicator with Connect 24
- Set the communication path: [300]
- Enable the alternate communicator: [382] option 5
- Enable event reporting: [307]/[308]
- Program communication delay timer: [377]
- Program DLS access: [401] option 07

Refer to the 3G2080(R)/ TL2803G(R)/ TL280(R) installation manual for details.

[300] Panel/Receiver Communication Paths

This section is used to select the path of communications between the alarm system and the central station.

To use PSTN as the communications path, program section [300] options 001 through 004 as [01] PSTN 1.

To use the alternate communicator to establish a communications path, program two of the receivers (section [300] options 001, 002, 003 or 004) as [03] and [04] for Ethernet, and two of the receivers as [05] and [06] for cellular.

Testing the System

Installer Walk Test

Walk test enables the installer to test the operation of each detector by tripping zones, causing an actual alarm. Enter section [901] to initiate a walk test. When a zone is tripped, all system sirens emit a tone to indicate that the zone is working correctly.

After 15 minutes without zone activity, the walk test terminates automatically. To manually exit walk test mode, enter [901] again.

Viewing the Event Buffer

The event buffer contains logs of events that have occurred on the alarm system beginning with the most recent. The capacity of the event buffer is scalable and can hold 500/1000 events (depending on panel model) before rolling over. The buffer displays events according to their time stamp, beginning with the most recent. The event buffer can be uploaded using DLS.

Each event displays the time and date, a description of the event, the zone label, access code number or any other pertinent information. To view the event buffer, press [*][6][Master Code][*].

Troubleshooting

LCD programmable-message keypad:

- Press [*][2] followed by access code if required to view a trouble condition
- The trouble light flashes and the LCD displays the first trouble condition
- Use the arrow keys to scroll through all trouble conditions present on the system

Note: When additional information is available for a specific trouble condition, a [*] is displayed. Press the [*] key to view the additional information.

LED and ICON keypads:

- Press [*][2] to view a trouble condition
- The trouble light flashes
- Refer to the trouble summary list below to determine the trouble condition(s) present on the system

[*][2] Trouble Display

This feature is used to view system troubles. If a trouble is present, the keypad Trouble indicator illuminates and an audible indication is emitted (two short beeps every 10 seconds, except while in AC failure). Silence the audible indicator by pressing [#].

Troubles may be viewed while the system is armed or disarmed. The system may be programmed to show all troubles while armed or only fire troubles.

The system can be configured to require a user code to view [*][2] system troubles. See section [023] option 5.

To view trouble conditions:

- Press [*][2] to enter the Trouble menu.
- On an LCD keypad, scroll to a trouble type then press [*] to view the specific trouble. The zone name and trouble condition for each trouble are displayed on the screen.
- On LED/ICON keypads, zone indicator lights illuminate to identify existing trouble types (e.g., Zone light 1 represents Service Required trouble type). Press the number key corresponding to a zone light to view the specific trouble. Lights 1-12 illuminate to indicate the trouble as follows:

Table 1-7 : Trouble Indications

Trouble 01 – Service Required:

- [01] Bell Circuit Trouble: The bell circuit is open.
- [02] RF Jam: The HSM2HOSTx has detected an RF Jam condition.
- [03] Aux Supply Trouble: The alarm controller, HSM2204 or HSM2300 has an overcurrent condition on Aux.
- [04] Loss of Clock: System time and date require programming.
- [05] Output 1 Fault: An HSM2204 module has detected an open condition on output #1.

Trouble 02 – Battery Trouble:

- [01] Panel Low Battery Trouble: The battery voltage (under load) is below 11.5V. Restores at 12.5V.
- [02] Panel No Battery: No battery connected to alarm controller.
- [04] HSM2204 01 - 04 Low Battery: An HSM2204 has a battery voltage less than 11.5V.
- [05] HSM2204 01 - 04 No Battery: No battery connected to HSM2204.
- [07] HSM2300 01 - 04 Low Battery: An HSM2300 has a battery voltage less than 11.5V
- [08] HSM2300 01 - 04 No Battery: No battery connected to HSM2300.

Trouble 03 – Bus Voltage:

- [01] HSM2HOSTx Bus Low Voltage: The HSM2HOSTx module has measured less than 6.3V on its Aux input.
- [02] Keypad 01 - 16 Bus Low Voltage: A hardwired keypad has a bus voltage of less than 6.9V for ICON/LCD (RF version) and 7.7V for non-RF models.
- [04] HSM2108 01 - 15 Bus Low Voltage: A zone expander has a bus voltage of less than 5.9V.
- [05] HSM2300 01 - 04 Bus Low Voltage: A power supply has a bus voltage of less than 6.9V.
- [06] HSM2204 01 - 04 Bus Low Voltage: A high current output module has a bus voltage of less than 6.9V.
- [08] HSM2208 01 - 16 Bus Low Voltage: The low current output module has detected a voltage less than 5.9V on its aux input.
- [09] HSM2955 Bus Low Voltage: The audio module has detected a voltage less than 9.65V on its aux input.

Trouble 04 – AC Troubles:

- [01] Zone 001 - 128 AC Trouble: An AC trouble has been detected on a PGX934 PIR + Camera.
- [03] Siren 01 - 16 AC: A siren has an AC trouble.
- [04] Repeater 01 - 08 AC: A wireless repeater has an AC trouble.
- [05] HSM2300 01 - 04 AC: An HSM2300 has an AC trouble.
- [06] HSM2204 01 - 04 AC: An HSM2204 has an AC trouble.
- [07] Panel AC: The alarm controller has an AC failure condition.

Trouble 05 – Device Faults:

- [01] Zone 001 - 128: A zone is in fault. Additional information displayed on LCD keypads for the following troubles: Fire Trouble (2-W Smoke, PGX916, PGX926, PGX936), Heat (PGX946), Freeze (PGX905), CO (PGX913), and Probe Disconnected (PGX905). Also generated by a short on hardwired zones when DEOL is used or by a wireless supervisory fault.
- [02] Keypad 01 - 16: A wireless or hardwired keypad is in fault.
- [03] Siren 01 - 16: A siren is in fault.
- [04] Repeater 01 - 08: A wireless repeater is in fault (supervisory or loss of AC/DC).

Trouble 06 – Device Low Battery:

- [01] Zone 001- 128: Wireless zone has a low battery.
- [02] Keypad 01-16: Keypad has a low battery.
- [03] Siren 01 - 16: Siren has a low battery.
- [04] Repeater 01 - 08: Repeater has a low battery.
- [05] User 01 - 95: Wireless Key has a low battery.

Trouble 07 – Device Tamper:

- [01] Zone 001 - 128 Tamper: A wireless or hardwired zone configured for DEOL operation is in tamper.
- [02] Keypad 01 - 16 Tamper: A hardwired or wireless keypad is in tamper.
- [03] Siren 01 - 16 Tamper: A wireless siren is in tamper.
- [04] Repeater 01 - 08 Tamper: A wireless repeater is in tamper.
- [05] Audio Station 01 - 04 Tamper: An audio station connected to an HSM2955 is in tamper.

Trouble 08 – RF Delinquency Trouble:

[01] Zone 001 - 128 RF Delinquency: No response from a wireless zone for 13 minutes. This trouble prevents arming until acknowledged or cleared using [*][2].

[02] Keypad 01 - 16 RF Delinquency: No response from a wireless keypad for 13 minutes.

[03] Siren 01 - 16 RF Delinquency: No response from a wireless siren for 13 minutes.

[04] Repeater 01 - 16 RF Delinquency: No response from a wireless repeater for 13 minutes.

Trouble 09 – Module Supervisory Trouble:

[01] HSM2HOSTx not responding.

[02] Keypad 01 - 16 not responding.

[04] HSM2108 01 - 15 not responding.

[05] HSM2300 01 - 04 not responding.

[06] HSM2204 01 - 04 not responding.

[08] HSM2208 01 - 16 not responding.

[09] HSM2955 is not responding.

Trouble 10 – Alternate Communicator Tamper:

[01] HSM2HOSTx Tamper.

[02] Keypad 01 - 16 Tamper.

[04] HSM2108 01 - 15 Tamper.

[05] HSM2300 01 - 04 Tamper.

[06] HSM2204 01 - 04 Tamper.

[08] HSM2208 01 - 16 Tamper.

[09] HSM2955 Tamper

Trouble 11 – Communications:

[01] TLM: Telephone line disconnected from control panel.

[02] Receiver 01-04 FTC Trouble: Failure to communicate using programmed receiver paths.

[03] Alt. Comm SIM Lock: SIM card has incorrect or unrecognized PIN.

[04] Alt. Comm Cellular: Radio or SIM card failure, low signal strength detected, or cellular network fault.

[05] Alt. Comm Ethernet: Ethernet connection unavailable. A valid IP address is either not programmed or the module was unable to get an IP with DHCP.

[06] Receiver 01-04 Absent: Alternate communicator unable to initialize a receiver.

[07] Receiver 01-04 Supervision: Alternate communicator unable to communicate with a receiver.

[09] Alt. Comm Fault: The alternate communicator has stopped responding.

[10] Alt Comm FTC Trouble: The alternate communicator has failed to communicate an internal event not generated by the panel.

Trouble 12 – Not Networked Troubles:

[01] Zone 001-128 Not Networked Trouble: Generated when a zone becomes out of sync with the wireless network or has not been synchronized with the network after enrollment.

[02] Keypad 01-16 Not Networked Trouble: Generated when a keypad becomes out of sync with the wireless network or has not been synchronized with the network after enrollment.

[03] Siren 01-16 Not Networked Trouble: Generated when a siren becomes out of sync with the wireless network or has not been synchronized with the network after enrollment.

[04] Repeater 01-08 Not Networked Trouble: Generated when a repeater becomes out of sync with the wireless network or has not been synchronized with the network after enrollment.

[05] User 01 - 95 Not Networked Trouble: Generated when a wireless key becomes out of sync with the wireless network or has not been synchronized with the network after enrollment.

IMPORTANT!

Ensure you have the following information available before contacting Customer Support :

- Alarm controller type and version, (e.g., HSM2064 1.0):

Note: Version number can be accessed by entering [*][Installer Code][900] on any LCD keypad. This information is also located on a sticker on the printed circuit board.

- List of modules connected to control panel, (e.g., HSM2108, HSM2HOSTx etc.) .

Specifications**Zone Configuration**

- 16, 32, 64, or 128 wireless zones supported and 8 hardwired zones available on the controller
- 40 zone types and 14 programmable zone attributes
- Zone configurations available: normally closed, single EOL and DEOL supervised
- Hardwired zone expansion (fully supervised) available using the model HSM2108 (eight zone expander module)
- Wireless zone expansion (fully supervised) available using the HSM2Host 2-way wireless integration module (operating at 915MHz (North America), 433MHz (Europe) and 868MHz (international))

Access Codes

- Up to 97 access codes: 94 (level 2-EN), one system master code (level 3-EN), one installer code (level 3-EN), and one maintenance code
- Programmable attributes for each user code (see "Access Code Attributes" on page 1)1,000,000 access code variations (using 6-digit codes)
- When using 6-digit access codes, the minimum number of variations of access codes are 10526 for HS2128/HS2064,13888 for HS2032 and 20833 for HS2016

Warning Device Output

- Integral sounder capable of 85 dB @ 3m, self-powered type Z
- 2 remote, wireless indoor/outdoor warning devices supported: models PGX901 (indoor), PGX911 (outdoor) (X=4, 8, or 9)
- Programmable as steady, pulsed or temporal three (as per ISO8201) and temporal four (CO alarm) output
- Warning device sounds alarms in the following priority: fire, CO, burg

Memory

- CMOS EEPROM memory
- Retains programming and system status on AC or battery failure for 20 years min. (not verified by UL)

Power Supply

Transformer: DSC PTD1640U

Primary: 120V, 60Hz Class II

Secondary: 16.5VAC, 40VA Max.

- 1.7A regulated, supervised and integral to the control unit
- Type A as per EN50131-6 Standard
- Input ratings: 220V-240Vac, 50/60Hz, 200mA
- Transformer required, mounted in the same enclosure, permanently connected
- Transformer secondary ratings: 16.5Vac, 40VA min.

Note: For installations using the transformer mounted inside the cabinet, replace fuse only with the same type (20mm) rated 250V/315mA.

Regulated power supply:

- 700mA auxiliary supply, 12V DC
- Positive temperature coefficient (PTC) for Bell, Aux+ and Battery terminals
- Reverse battery detection/protection
- Supervision for AC power and low battery
- Normal and high current battery charge options
- Supervised battery charging circuit

Current draw (panel):

- 85mA (nominal) 2A(Max)

Bell Output:

- 12V, 700mA supervised (1k Ohm) bell output (current limited at 2 amps)
- Steady, Pulsed, Temporal 3 fire, CO alarm cadences
- Bell short detection (software + hardware)

Aux+:

- Voltage range = 9.6V - 13.8V DC
- Current = 700mA (shared with PGM outputs)
- Output ripple voltage: 270mVp-p max.
- Onboard programmable outputs:
 - PGM 1 - 50mA switched programmable output
 - PGM 2 - 300mA current-limited switched programmable output. 2-Wire smoke detectors (90mA current limited) are supported using this PGM
 - PGM 3 - 50mA switched programmable output
 - PGM 4 - 50mA switched programmable output
 - Hardware PGM over current protection

Battery

- 12V sealed lead acid, rechargeable
- Battery capacity:
 - 4Ah (PS4-12)
 - 7Ah (BD7-12)
 - 14Ah
- Maximum standby time: 24 hours (with 14Ah battery and Aux current limited to 470mA)
- Recharging time to 80% 72 hours
- Recharging rate: 240mA (12 hours max.), 480mA (24 hour backup)
- Backup time: 24 hours (UL)
- Battery lifespan: 3-5 years
- Low battery trouble indication threshold 11.5VDC
- Battery restore voltage 12.5V
- Main board current draw (battery only):
 - HS2016/32/64/128 (no alternate communicator) standby 85mA DC
 - HS2016/32/64/128, (including alternate communicator) standby 190mA DC
 - Transmit (alternate communicator module) 195mA DC
- Resettable fuses (PTC) used on circuit board
- Supervision for loss of primary power source (AC fail), battery loss or battery low voltage (battery trouble) with indication provided on the keypad
- Internal clock locked to AC power frequency

Operating Environmental Conditions

- Temperature range: UL= 0°C to +49°C (32°F-120°F),
- Relative humidity: <93% non condensing

Alarm Transmitter Equipment (ATE) Specification

- Digital dialer integral to the main control board
- Supports SIA and Contact ID
- Complies with TS203 021-1, -2, -3 Telecom equipment requirements and EN50136-1-1, EN50136-2-1, EN50136-2-3 ATS 2
- Optional Dual IP/Cellular communicators (3G2080(R)/ TL2803G (R)/ TL280(R)) can be installed in the same enclosure and configured as primary or back-up, with AES 128-bit encryption
- Compliant with EN50136-1-1, EN50136-2-1 ATS2 requirements

System Supervision Features

The PowerSeries Neo continuously monitors a number of possible trouble conditions and provides audible and visual indication at the keypad.

Trouble conditions include:

- AC power failure
- Zone trouble
- Fire trouble

- Telephone line trouble
- Communicator trouble
- Low battery condition
- RF jam
- AUX power supply fault
- Failure to communicate
- Module fault (supervisory or tamper)

Additional Features

- 2-way wireless device support
- Visual verification (images + audio)*
- Proximity tag support
- PGM scheduling
- Quick arming
- User, partition, module, zone and system labels
- Soak test*
- Programmable system loop response
- Keypad and panel software versions viewable through keypad
- Doorbell zone type
- Low battery PGM type

*Feature not evaluated by UL/ULC.

Programming Directory

This section provides a list of all available programming options in numerical order. To program, access Installer Programming mode by keying in [*][8][Installer Code]. Use the scroll keys to navigate through the menus or jump directly to a specific section by keying in a section number and pressing [*]. Programming consists of toggling on and off options in each section or by populating data fields. Press [*] to select options and [#] to exit to the previous menu. For descriptions of all programming options and programming worksheets, refer to the PowerSeries Neo Reference Manual. ✓ = Default

Label Programming

000 Label Programming

- 000 – Language Selection (01)
- 001 – Zone Labels
 - 001-128 – Zone Labels 1-128
- 051 – Zone Tamper Label
- 052 – Zone Fault Label
- 064 – CO Alarm Message
- 065 – Fire Alarm Message
- 066 – Fail to Arm Event Message
- 067 – Alarm When Armed Event Message
- 100 – System Label
- 101-108 – Partition 1-8 Labels
- 201- 208 – Partition 1-8 Command Output Labels
 - 001-004 – Command output 1-4 Labels
- 601-604 – Schedule 1- 4 Labels
- 801 – Keypad Labels
 - 001-016 Keypad 1-16 Labels
- 802 – Zone Expander Labels
 - 001-015 – Zone Expander 1-15 Labels
- 803 – Output Expander Labels
 - 001 Output Expander 1 Label
- 806 – HSM2HOST Label
- 808 – HSM2955 Label
- 809 – Power Supply Label
 - 001-004 Power Supply 1-4 Label
- 810 – High Current Output Supply Label
 - 001-004 Power Supply 1-4 Label
- 815 – Alternate Communicator Label
- 820 – Siren Label
 - 001-016 Siren 1-16 Label
- 821 – Repeater Label
 - 001-008 Repeater 1-8 Label
- 999 – Default Labels

Zone Type

001 Zone Type

- 001-128 Zone Types (000)
 - 000 – Null Zone
 - 001 – Delay 1
 - 002 – Delay 2
 - 003 – Instant
 - 004 – Interior
 - 005 – Interior Stay/Away
 - 006 – Delay Stay/Away
 - 007 – Delayed 24-Hour Fire
 - 008 – Standard 24-Hour Fire
 - 009 – Instant Stay/Away
 - 010 – Interior Delay
 - 011 – Day Zone
 - 012 – Night Zone
 - 016 – Final Door Set
 - 017 – 24-Hour Burglary
 - 018 – 24-Hour Bell/Buzzer

- 023 – 24-Hour Supervisory
- 024 – 24-Hour Supervisory Buzzer
- 025 – Auto Verify Fire
- 027 – Fire Supervisory
- 040 – 24-Hour Gas
- 041 – 24-Hour CO
- 042 – 24-Hour Holdup
- 043 – 24-Hour Panic
- 045 – 24-Hour Heat
- 046 – 24-Hour Medical*
- 047 – 24-Hour Emergency
- 048 – 24-Hour Sprinkler
- 049 – 24-Hour Flood
- 051 – 24-Hour Latching Tamper
- 052 – 24-Hour Non-Alarm
- 056 – 24-Hour High Temperature
- 057 – 24 Hour Low Temperature
- 060 – 24-Hour Non-Latching Tamper
- 066 – Momentary Keyswitch Arm
- 067 – Maintained Keyswitch Arm
- 068 – Momentary Keyswitch Disarm
- 069 – Maintained Keyswitch Disarm
- 071 – Doorbell Zone
- 072 – Push to Set

002 – Zone Attributes

001-0128 (see PowerSeries Neo reference manual for defaults)

- 1 – Bell Audible
- 2 – Bell Steady
- 3 – Door Chime
- 4 – Bypass Enabled
- 5 – Force Arm
- 6 – Swinger Shutdown
- 7 – Transmission Delay
- 8 – Burglary Verification
- 9 – Normally Closed EOL
- 10 – Single EOL
- 11 – Double EOL
- 12 – Fast Loop/Normal Loop Response
- 13 – Zone 2-way Audio Activation
- 14 – Holdup Verification

System Times

005 System Times

- 000 – System Area
 - Bell Cutoff (004 min.)
 - Bell Delay Time (000 min.)
 - Burglary Verification Timer (060 sec.)
 - Holdup Verification Timer (008 sec.)

- Zone Loop Response (250 ms)
- Automatic Clock Adjust (060 sec.)

001 – 008 System Times - Partition 1-8

- Entry Delay 1 (030 sec.)
- Entry Delay 2 (045 sec.) (CP-01 030 sec.)
- Exit Delay (120 sec.) (CP-01 060 sec.)
- Settle Delay (010 sec.) (CP-01 000 sec.)

900 – Bell Delay Partition Mask (Y,Y,Y,Y,Y,Y,Y,Y)

901 – Daylight Savings Begin:

- Month (003)
 - Week (002)
 - Day (000)
 - Hour (002)
 - Increment (001)
- ### 902 – Daylight Savings End
- Month (011)
 - Week (001)
 - Day (000)
 - Hour (002)
 - Decrement (001)

Access Codes

006 Installer Defined Access Codes

(4-digit decimal)

- 001 – Installer Code (555555)
- 002 – Master Code (123456)
- 003 – Maintenance Code (AAAA00)

PGM Programming

007 – PGM Programming

000 – Main Bell Partition Assignment

- 1 – Partition 1
- 2 – Partition 2
- 3 – Partition 3
- 4 – Partition 4
- 5 – Partition 5
- 6 – Partition 6
- 7 – Partition 7
- 8 – Partition 8

001-164 – PGM 1-164 Partition Assignment (default: partition 1)
1-8 – Partition 1-8

008 – PGM Timer Programming

000 – PGM Timer-Minutes or Seconds (seconds)
001-164 – PGM 1-164 Timer (005)

009 – PGM Types

001-164 – PGM 1-164 Type Assignment (default: PGM1=121, PGM2=156, 3-164=101)
100 – Null PGM
101 – Burg and Fire Bell Follower
102 – Delayed Fire and Burg
103 – Sensor Reset [*][7][2]

- 104 – 2-Wire Smoke
- 109 – Courtesy Pulse
- 111 – Keypad Buzzer Follow
- 114 – Ready To Arm
- 115 – System Armed Status
- 116 – Away Armed Status
- 117 – Stay Armed Status
- 120 – Away Armed with no Zone Bypass Status
- 121 – Command Output 1
- 122 – Command Output 2
- 123 – Command Output 3
- 124 – Command Output 4
- 129 – Partition Status Alarm Memory
- 132 – Holdup Output
- 134 – 24Hr Silent Input
- 135 – 24Hr Audible Input
- 146 – TLM and Alarm
- 147 – Kissoff
- 148 – Ground Start
- 149 – Alternate Communicator
- 155 – System Trouble
- 156 – Latched System Event
- 157 – System Tamper
- 161 – DC Trouble
- 165 – Prox Used
- 175 – Bell Status and Programming Access Output
- 176 – Remote Operation
- 184 – Open After Alarm
- 200 – Zone Follower
- 201 – Follower-Zones 1-8
- 202 – Follower-Zones 9-16
- 203 – Follower-Zones 17-24
- 204 – Follower-Zones 25-32
- 205 – Follower-Zones 33-40
- 206 – Follower-Zones 41-48
- 207 – Follower-Zones 49-56
- 208 – Follower-Zones 57-64
- 209 – Follower-Zones 65-72
- 210 – Follower-Zones 73-80
- 211 – Follower-Zones 81-88
- 212 – Follower-Zones 89-96
- 213 – Follower-Zones 97-104
- 214 – Follower-Zones 105-112
- 215 – Follower-Zones 113-120
- 216 – Follower-Zones 120-128

010 PGM Attributes

- 000 – Main Bell Mask
 - Fire Alarm ✓
 - CO Alarm ✓
 - Burglary Alarm ✓
 - 24-Hour Flood Alarm ✓
 - Bell Squawks ✓
- 001-164 PGM 1-164 Attributes
- 100 – Null PGM
- 101 – Fire and Burglary
 - 01 – True Output ✓
 - 03 – Code Required ✓

✓ = Default

- 102 – Delay Fire and Burglary
 - 01 – True Output
- 103 – Sensor Reset [*][7][2]
 - 03 – Code Required
- 109 – Courtesy Pulse
 - 01 – True Output
- 111 – Keypad Buzzer Follow
 - 01 – True Output ✓
 - 02 – Timed Output
 - 09 – Entry Delay ✓
 - 10 – Exit Delay ✓
 - 11 – Door Chime ✓
 - 12 – Keypad Buzzer Zone ✓
 - 13 – Audible Exit Fault ✓
 - 14 – Auto-Arm Pre-Alert ✓
- 114 – Ready To Arm
 - 01 – True Output ✓
- 115 – Armed Status
 - 01 – True Output ✓
- 116 – Armed Away Mode
 - 01 – True Output ✓
- 117 – Armed Stay Mode
 - 01 – True Output ✓
- 121 - 124 – Command Output 1-4
 - 01 – True Output ✓
 - 02 – Timed Output ✓
 - 03 – Code Required ✓
(NZ off)
- 129 – Partition Status Alarm
- Memory
 - 01 – True Output ✓
- 132 – Holdup Output
 - 01 – True Output ✓
 - 02 – Timed Output
- 146 – TLM and Alarm
 - 01 – True Output ✓
- 147 – Kissoff Output
 - 01 – True Output ✓
- 148 – Ground Start
 - 01 – True Output ✓
- 149 – Alternate Communicator
 - 01 – True Output ✓
 - 02 – Timed Output ✓
 - 04 – Fire Alarm
 - 05 – Panic Alarm
 - 06 – Burglary Alarm
 - 07 – Open/Close
 - 08 – Zone Auto Bypass
 - 09 – Medical Alarm
 - 10 – Burglary Verified
 - 11 – Open after Alarm
 - 12 – Emergency Alarm
 - 13 – Duress Alarm
 - 14 – Holdup Verified
- 155 – System Trouble
 - 01 – True Output ✓
 - 02 – Timed Output
 - 04 – Service Required ✓
 - 05 – Loss of Clock ✓
 - 06 – AC Fail ✓
 - 07 – DC Fail ✓
 - 08 – TLM ✓
 - 09 – FTC ✓
 - 10 – Ethernet ✓
 - 11 – Zone Fault ✓
 - 12 – Zone Tamper ✓
 - 13 – Zone Low Battery ✓
- 156 – Latched System Event
 - 01 – True Output ✓
 - 02 – Timed Output
 - 04 – Fire Alarm ✓
 - 05 – Panic Alarm ✓
 - 06 – Burglary Alarm ✓
 - 07 – Medical Alarm ✓
 - 08 – Supervisory ✓
 - 09 – Priority Event ✓
 - 10 – Holdup ✓
 - 11 – Duress ✓
 - 12 – Emergency ✓
 - 13 – Fire Supervisory ✓
 - 14 – Fire Trouble ✓
 - 15 – CO Alarm ✓
- 157 – System Tamper
 - 01 – True Output ✓
 - 02 – Timed Output
 - 09 – Module Tamper ✓
 - 10 – Zone Tamper ✓
- 161 – DC Trouble
 - 01 – True Output ✓
 - 02 – Timed Output
 - 09 – Battery Low ✓
 - 10 – Battery Absent ✓
- 165 – Prox Used
 - 01 – True Output ✓
- 175 – Bell Prog Access
 - 01 – True Output ✓
- 176 – Remote Operation
 - 01 – True Output ✓
- 184 – Open After Alarm
 - 01 – True Output ✓
 - 02 – PGM Timer ✓
- 201- 216 Zone Follow Zones 1-128
 - 01 – True Output ✓
 - 02 – Timed Output
 - 09-016 – Zone Terminal 1-16
- 011 PGM Configuration Options**
 - 001-164 – PGM 1-164 Configuration
 - Zone Follower by Zone
 - Proximity Tag Used
 - Command Output Schedules
- 012 System Lockout (attempts/min.)**
 - Keypad Lockout Attempts (000)
 - Keypad Lockout Duration (000)
 - Remote Lockout Attempts (006)
 - Remote Lockout Duration (060)
- System Options**
- 013 System Options 1**
 - 1 – NC Loop/EOL
 - 2 – DEOL/SEOL
 - 3 – Show All Troubles when Armed ✓
 - 4 – Tamper/Faults Do Not show as open
 - 5 – Auto-Arm Schedule in [*][6] ✓
 - 6 – Audible Exit Fault ✓
 - 7 – Event Buffer Follows Swinger ✓
 - 8 – Temporal Three Fire Signaling
- 014 System Options 2**
 - 1 – Bell Squawk
 - 2 – Bell Squawk Auto-Arm
 - 3 – Bell Squawk on Exit
 - 4 – Bell Squawk on Entry
 - 5 – Bell Squawk on Trouble
 - 6 – Not Used
 - 7 – Exit Delay Termination
 - 8 – Fire Bell Continues
- 015 System Options 3**
 - 1 – [F] Key ✓
 - 2 – [P] Key Annunciation
 - 3 – Quick Exit
 - 4 – Quick Arming/Function Key ✓
 - 5 – Not Used
 - 6 – Master Code Not User Changeable
 - 7 – Telephone Line Monitor Enable ✓
 - 8 – TLM Audible When Armed
- 016 System Options 4**
 - 1 – AC Trouble Display ✓
 - 2 – AC Trouble Light Flashes
 - 3 – Keypad Blanking
 - 4 – Keypad Blanking Requires Code
 - 5 – Keypad Backlighting ✓
 - 6 – Power Save Mode
 - 7 – Bypass Display When Armed
 - 8 – Keypad Tamper Enabled
- 017 System Options 5**
 - 1 – Chime On Opening
 - 2 – Chime On Closing
 - 3 – RF Jam Audible
 - 4 – Multi-Hit
 - 5 – Late to Close
 - 6 – Daylight Savings Time
 - 7 – Not Used
 - 8 – Bell Squawk on Away Arm/Disarm Only
- 018 System Options 6**
 - 1 – Test Transmission Exception
 - 2 – Real-Time Bypass Reporting
 - 3 – Not Used
 - 4 – Not Used
 - 5 – Keypad Buzzer Alarm
 - 6 – Not Used
 - 7 – Exit Delay Restart (CP-01) ✓
 - 8 – AC Fail Trouble Beeps
- 019 System Options 7**
 - 1 – Audible Wireless Zone Fault
 - 2 – Latching Troubles
 - 3 – Not Used
 - 4 – R-Button
 - 5 – Audible Bus Fault
 - 6 – Duress Codes
 - 7 – Temperature in Celsius ✓
 - 8 – Reset After Zone Activation
- 020 System Options 8**
 - 1 – Access Code Entry During Entry Delay
 - 2 – EU Entry Procedure
 - 3 – [*][8] Access While Armed
 - 4 – Remote Reset
 - 5 – Engineer's Reset
- 6 – Keyswitch Disarming During Entry Delay
- 7 – Installer Access and DLS
- 8 – Troubles Inhibits Arming
- 021 System Options 9**
 - 1 – Trbl Display
 - 2 – Keypad Blanking while armed
 - 3 – Auto-Arming Bypass
 - 4 – Ready Display
 - 5 – PGM Keypad Blanking
 - 6 – Armed Display
 - 7 – Open Cancels Arming
 - 8 – Audible Exit Delay for Stay Arming
- 022 System Options 10**
 - 1 – [F] Key Option
 - 2 – Not Used
 - 3 – Not Used
 - 4 – Test Transmission Counter in Hours
 - 5 – Away to Stay Toggle
 - 6 – 2-Way Full Duration ✓
 - 7 – Trouble Beeps Are Silent
 - 8 – Keyswitch Arms in Away Mode
- 023 System Options 11**
 - 1 – Ready LED Flash for Force Arm
 - 2 – Not Used
 - 3 – Tamper/Fault Detection
 - 4 – Access Code Required for [*][1]
 - 5 – Access Code Required for [*][2]
 - 6 – Access Code Required for [*][3]
 - 7 – Access Code Required for [*][4]
 - 8 – [*][6] Accessibility
- 024 System Options 12**
 - 1 – 50Hz AC / 60 Hz AC (ARG) ✓
 - 2 – Crystal Timebase
 - 3 – AC/DC Inhibits Arming
 - 4 – Tamper Inhibit Arm
 - 5 – Real Time Clock Option
 - 6 – Not Used
 - 7 – Not Used
 - 8 – DLS Disconnect
- 025 System Options 13**
 - 1 – European Dial (ARG) ✓
 - 2 – Force Dial ✓
 - 3 – Test Transmission Counter in Minutes
 - 4 – Not Used
 - 5 – ID Tone
 - 6 – Tone Generated-2100Hz
 - 7 – 1 Hour DLS Window
 - 8 – FTC Audible Bell
- 040 User Authentication**
 - 01 – User Code or Proximity Tag ✓
 - 02 – User Code and Proximity Tag
- 041 Access Code Digits**
 - 00 – 4-Digit Access Codes ✓
 - 01 – 6-Digit Access Codes

✓ = Default

042 Event Verification

- 01 – Burglary Verified Counter (002)
- 02 – Holdup Counter (002)
- 03 – Burglary Verification Selection

- 001 – Police Code ✓
- 002 – Cross Zoning
- 003 – EU Sequential Detection

151-158 Partition 1-8 Auto-Arm/Disarm

- 001 – Auto-Arming Times (9999)
 - 24-Hour
 - Sunday
 - Monday
 - Tuesday
 - Wednesday
 - Thursday
 - Friday
 - Saturday

- 002 – Auto-Disarm Times (9999)
 - 24-Hour
 - Sunday
 - Monday
 - Tuesday
 - Wednesday
 - Thursday
 - Friday
 - Saturday

- 003 – Auto-Disarming Holiday Schedule
 - Holiday 1
 - Holiday 2
 - Holiday 3
 - Holiday 4

- 004 – Auto-Arming Pre-Alert (004)

- 005 – Auto-Arming Postpone Timer (000)

- 006 – No Activity Arming Timer (000)

- 007 – No Activity Arming Pre-Alert Timer (001)

200 Partition Mask

- 001 – Partition 1 to 8 Enable Mask
 - 1 – Partition 1 ✓
 - 2 – Partition 2
 - 3 – Partition 3
 - 4 – Partition 4
 - 5 – Partition 5
 - 6 – Partition 6
 - 7 – Partition 7
 - 8 – Partition 8

201-208 Partition 1-8 Zone Assignment

- 001 – Zone 1-8 ✓
- 002 – Zn 9-16 ✓
- 003 – Zn 17-24
- 004 – Zn 25-32
- 005 – Zn 33-40
- 006 – Zn 41-48
- 007 – Zn 49-56
- 008 – Zn 57-64
- 009 – Zn 65-72
- 010 – Zn 73-80
- 011 – Zn 81-88

012 – Zn 89-96

013 – Zn 97-104

014 – Zn 105-112

015 – Zn 113-120

016 – Zn 121-128

300 Panel/Receiver Communications Path

- 001 – 004 Receiver 1-4
 - 01 – Phone Line ✓
 - 02 – Alt Comm Auto Routing
 - 03 – Alt Comm Rec 1-Ethernet
 - 04 – Alt Comm Rec 2-Ethernet
 - 05 – Alt Comm Rec 3-Cellular
 - 06 – Alt Comm Rec 4-Cellular

301 Phone Number Programming

- 001 – 004 Phone Number 1-4 Programming (DFFF...32-digit)

304 Call Waiting Cancel String (DB70EF)**Event Reporting****307 Zone Reporting**

- 001-128 Zone Reporting for Zones 1-128
 - 01 – Alarm ✓
 - 02 – Alarm Restore ✓
 - 03 – Tamper ✓
 - 04 – Tamper Restore ✓
 - 05 – Fault ✓
 - 06 – Fault Restore ✓

308 Event Reporting

- 001 – Miscellaneous Alarm 1
 - 01 – Duress Alarm ✓
 - 02 – Opening After Alarm ✓
 - 03 – Recent Closing Alarm ✓
 - 04 – Zone Expander Supervisory Alarm ✓
 - 05 – Zone Expander Supervisory Alarm Restore ✓
 - 06 – Burglary Verified ✓
 - 07 – Burg Not Verified Alarm ✓
 - 08 – Alarm Cancel ✓
- 002 – Miscellaneous Alarm 2
 - 01 – Holdup Verified Alarm ✓
- 011 – Priority Alarms
 - 01 – Keypad Fire Alarm-F Key ✓
 - 02 – Keypad Fire Restore ✓
 - 03 – Keypad Medical Alarm-M Key ✓
 - 04 – Keypad Medical Restore ✓
 - 05 – Keypad Panic Alarm (P) ✓
 - 06 – Keypad Panic Restore ✓
 - 07 – Auxiliary Input Alarm ✓
 - 08 – Aux Input Alarm Restore ✓
- 021 – Fire Alarms 1

- 03 – PGM 2 2-Wire Alarm ✓
- 04 – PGM 2 2-Wire Restore ✓

- 101 – Tamper Events
 - 03 – Module Tamper ✓
 - 04 – Module Tamper Restore ✓
 - 05 – Keypad Lockout ✓
 - 07 – Remote Lockout ✓
- 201 – Open/Close Events 1
 - 01 – User Closing ✓
 - 02 – User Opening ✓
 - 03 – Future Use
 - 04 – Future Use
 - 05 – Special Closing ✓
 - 06 – Special Opening ✓
 - 07 – Keypad Opening ✓
 - 08 – Keypad Closing ✓

- 202 – Open/Close Events 2
 - 01 – Automatic Closing ✓
 - 02 – Automatic Disarm ✓
 - 03 – Auto Arm Cancellation/Postpone ✓
- 211 – Miscellaneous Open/Close Events
 - 01 – Late to Close ✓
 - 02 – Late to Open ✓
 - 05 – Exit Fault ✓

- 221 – Bypass Events
 - 01 – Auto Zone Bypass
 - 02 – Auto Zone Unbypass
 - 03 – Partial Closing ✓

- 301 – Panel Events 1
 - 01 – Panel AC Fail Trouble ✓
 - 02 – Panel AC Fail Restore ✓
 - 03 – Panel Low Battery ✓
 - 04 – Panel Low Battery Restore ✓
 - 05 – Panel Battery Absent ✓
 - 06 – Panel Battery Absent Trouble Restore ✓

- 302 – Panel Events 2
 - 01 – Bell Circuit Trouble ✓
 - 02 – Bell Circuit Restore ✓
 - 03 – Telephone Line Trouble ✓
 - 04 – Telephone Line Trouble Restore ✓
 - 05 – Auxiliary Trouble ✓
 - 06 – Auxiliary Trouble Restore ✓

- 305 – Panel Events 5
 - 03 – PGM 2 2-Wire Trouble ✓
 - 04 – PGM 2 2-Wire Restore ✓

- 311 – Maintenance Events 1
 - 01 – RF Jam Trouble ✓
 - 02 – RF Jam Trouble Restore ✓
 - 03 – Fire Trouble ✓
 - 04 – Fire Trouble Restore ✓
 - 05 – Cold Start ✓
 - 06 – Delinquency ✓
 - 07 – Self Test Trouble ✓

- 08 – Self Test Trouble Restore ✓

- 312 – Maintenance Events 2
 - 01 – Installer Lead IN ✓
 - 02 – Installer Lead OUT ✓
 - 03 – DLS Lead IN ✓
 - 04 – DLS Lead OUT ✓
 - 05 – SA Lead IN ✓
 - 06 – SA Lead OUT ✓
 - 07 – Event Buffer 75% Full ✓

- 313 – Maintenance Events 3
 - 01 – Firmware Update Begin ✓
 - 02 – Firmware Update Success ✓
 - 03 – Firmware Update Fail ✓
- 314 – Maintenance Events 4
 - 01 – Gas Trouble ✓
 - 02 – Gas Trouble Restore ✓
 - 03 – Heat Trouble ✓
 - 04 – Heat Trouble Restore ✓
 - 05 – Freeze Trouble ✓
 - 06 – Freeze Trouble Restore ✓

- 07 – Probe Disconnected ✓
- 08 – Probe Disconnect Restore ✓
- 321 – Receiver Events
 - 02 – Receiver 1 FTC Restore ✓
 - 04 – Receiver 2 FTC Restore ✓
 - 06 – Receiver 3 FTC Restore ✓
 - 08 – Receiver 4 FTC Restore ✓

- 331 – Module Events 1
 - 01 – Module AC Trouble ✓
 - 02 – Module AC Trouble Restore ✓
 - 03 – Module Battery Trouble ✓
 - 04 – Module Battery Trouble Restore ✓
 - 05 – Module Battery Absent ✓
 - 06 – Module Battery Absent Restore ✓

- 332 – Module Events 2
 - 01 – Module Low Voltage ✓
 - 02 – Module Low Voltage Restore ✓
 - 03 – Module Supervisory ✓
 - 04 – Module Supervisory Restore ✓
 - 05 – Module Aux Trouble ✓
 - 06 – Module Aux Trouble Restore ✓

- 335 – Module Events 5
 - 01 – Output 1 Fault ✓
 - 02 – Output 1 Fault Restore ✓
- 351 – Alternate Communicator 1
 - 01 – Alt. Comm. Module Comm Fault ✓

✓ = Default

- 02 – Alt. Comm. Module Comm Fault Restore ✓
 - 07 – Alt. Comm. Radio/SIM Failure ✓
 - 08 – Alt. Comm. Radio/SIM Failure ✓ Restore
 - 352 – Alternate Communicator 2
 - 01 – Alternate Comm. Network Fault ✓
 - 02 – Alt. Comm. Network Fault Restore ✓
 - 05 – Alt. Comm. Ethernet ✓
 - 06 – Alt. Comm. Ethernet Trouble Restore ✓
 - 354 – Alternate Communicator 4
 - 01 – Alt. Comm Receiver 1 ✓
 - 02 – Alt. Comm Receiver 1 Restore ✓
 - 03 – Alt. Comm Receiver 2 ✓
 - 04 – Alt. Comm Receiver 2 Restore ✓
 - 05 – Alt. Comm Receiver 3 ✓
 - 06 – Alt. Comm Receiver 3 Restore ✓
 - 07 – Alt. Comm Receiver 4 ✓
 - 08 – Alt. Comm Receiver 4 Restore ✓
 - 355 – Alternate Communicator 5
 - 01 – Alt. Comm Receiver 1 Supervision Failure ✓
 - 02 – Alt. Comm Receiver 1 Supervision Failure Restore ✓
 - 03 – Alt. Comm Receiver 2 Supervision Failure ✓
 - 04 – Alt. Comm Receiver 2 Supervision Failure Restore ✓
 - 05 – Alt. Comm Receiver 3 Supervision Failure ✓
 - 06 – Alt. Comm Receiver 3 Supervision Failure Restore ✓
 - 07 – Alt. Comm Receiver 4 Supervision Failure ✓
 - 08 – Alt. Comm Receiver 4 Supervision Failure Restore ✓
 - 361 – Wireless Device Events
 - 01 – Device AC Fail ✓
 - 02 – Device AC Restore ✓
 - 03 – Device Low Battery ✓
 - 04 – Device Low Battery Restore ✓
 - 05 – Device Fault ✓
 - 06 – Device Fault Restore ✓
 - 401 – System Test Events
 - 01 – Walk Test Start ✓
 - 02 – Walk Test End ✓
 - 03 – Periodic Test Transmission ✓
 - 04 – Periodic Test Transmission with Trouble ✓
 - 05 – System Test ✓
- Communications**
- 309 System Call Direction**
- 001 – Maintenance Events
 - 1 – Receiver 1 ✓
 - 2 – Receiver 2
 - 3 – Receiver 3
 - 4 – Receiver 4
 - 002 – Test Transmission Events
 - 1 – Receiver 1 ✓
 - 2 – Receiver 2
 - 3 – Receiver 3
 - 4 – Receiver 4
- 310 Account Codes**
- 000 – System Account Code (FFFF)
 - 001-008 – Partition 1-8 Account Code (FFFF)
- 311-318 Partition 1-8 Call Direction**
- 001 – Partition Burglary Alarm/Restore Call Direction
 - 1 – Receiver 1 ✓
 - 2 – Receiver 2
 - 3 – Receiver 3
 - 4 – Receiver 4
 - 002 – Partition Tamper/Restore Call Direction
 - 1 – Receiver 1 ✓
 - 2 – Receiver 2
 - 3 – Receiver 3
 - 4 – Receiver 4
 - 003 – Partition Opening/Closing Call Direction
 - 1 – Receiver 1 ✓
 - 2 – Receiver 2
 - 3 – Receiver 3
 - 4 – Receiver 4
- 350 Communicator Formats (04 - SIA)**
- 001 – Communicator Format - Receiver 1
 - 002 – Communicator Format - Receiver 2
 - 003 – Communicator Format - Receiver 3
 - 004 – Communicator Format - Receiver 4
- 377 Communication Variables**
- 001 – Swinger Shutdown Attempts
 - Alarms and Restore (003) (CP-01 002 sec.)
 - Tamper and Restore (003) (003)
 - 002 – Communication Delays
 - Zone Delay (000 sec.)(CP-01 030 sec.)
 - AC Failure Communication Delay (030 min./hrs.)
 - TLM Trouble Delay (010 sec. x 3)
 - WLS Zone Low Battery Transmission Delay (007 days)
 - Delinquency Transmission Delay (030 hours/days)
 - Communications Cancel Window (000 min.) (CP-01 005 sec.)
 - 003 – Periodic Test Transmission Cycle (030 hrs./days)
 - 004 – Periodic Test Transmission Time of Day (9999)
 - 011 – Maximum Dialing Attempts (005)
 - 012 – PSTN Delay (003 sec.)
 - 013 – Delay Between Force Attempts (020 sec.)
 - 014 – Post Dial Wait for Handshake (040 sec.)
 - 015 – T-Link Wait for Ack (060 sec.)
 - 016 – IP/Cellular Fault Check Timer (010)
- 380 Communicator Option 1**
- 1 – Communications Enabled ✓
 - 2 – Restore on Bell Timeout
 - 3 – Pulse Dialing
 - 4 – Pulse Dial After 5th Attempt
 - 5 – Parallel Communications
 - 6 – Alternate Dial ✓
 - 7 – Reduced Dialing Attempts
 - 8 – Activity Delinquency
- 381 Communicator Option 2**
- 1 – Keypad Ringback
 - 2 – Bell Ringback
 - 4 – Closing Confirmation
 - 8 – Communications Priority
- 382 Communicator Option 3**
- 2 – Walk Test Communication
 - 4 – Call Waiting Cancel
 - 5 – Alternate Communicator Enable
 - 6 – AC Failure TX in Hours
 - 8 – Tamper Limit
- 383 Communicator Option 4**
- 1 – Phone Number Account Code
 - 2 – 6-Digit Account Code
 - 5 – Communicate FTC Events
- 384 Communicator Backup Options**
- 2 – Backup Options - Receiver 2 ✓
 - 3 – Backup Options - Receiver 3
 - 4 – Backup Options - Receiver 4
- 385 Audio Module Talk/Listen Mask**
- 1 – Talk/Listen on Phone Number 1
 - 2 – Talk/Listen on Phone Number 2
 - 3 – Talk/Listen on Phone Number 3
 - 4 – Talk/Listen on Phone Number 4
- DLS Programming**
- 401 DLS/SA Options**
- 1 – Double Call
 - 2 – User Enables DLS ✓
 - 3 – DLS Callback
 - 4 – User Call Up
 - 6 – Panel Call-Up and Baud Rate
 - 7 – Alt. Comm DLS ✓
- 402 DLS Phone Number Programming (31-digit decimal)**
- 403 DLS Access Code (default is based on model)**
- HS2128 Models (212800)
 - HS2064 Models (206400)
 - HS2032 Models (203200)
 - HS2016 Models (201600)
- 404 DLS/SA Panel ID (default is based on model)**
- HS2128 Models (2128000000)
 - HS2064 Models (2064000000)
 - HS2032 Models (2032000000)
 - HS2016 Models (2016000000)
- 405 PSTN Double Call Timer (060 sec.)**
- 406 PSTN Number of Rings to Answer On (000)**
- 407 SA Access Code (FFFFFF)**
- 410 Automatic DLS Options**
- 001 – Automatic DLS Toggle Options
 - 1 – Periodic DLS
 - 3 – DLS on Event Buffer 75% Full
 - 5 – SA on Event Buffer 75% Full
 - 8 – DLS On Programming Change
 - 002 – Periodic DLS Days (000 days)
 - 003 – Periodic DLS Time (0000)
 - 007 – Delay Call Window
 - Delay Call Window Start (0000)
 - Delay Call Window End (0000)
- 560 Virtual Inputs (000)**
- 001 - 032 – Virtual Input 1-32
- Schedule Programming**
- 601-604 Programming Schedule 1-4**
- 101 – Interval 1 Start Time (0000)
 - 102 – Interval 1 End Time (0000)
 - 103 – Interval 1 Days Assignment
 - 01 – Sunday
 - 02 – Monday
 - 03 – Tuesday
 - 04 – Wednesday
 - 05 – Thursday
 - 06 – Friday
 - 07 – Saturday
 - 104 – Interval 1 Holiday Assignment
 - 09 – Holiday 1
 - 10 – Holiday 2
 - 11 – Holiday 3
 - 12 – Holiday 4
 - 201 – Interval 2 Start Time (0000)
 - 202 – Interval 2 End Time (0000)
 - 203 – Interval 2 Days Assignment
 - 01 – Sunday
 - 02 – Monday
 - 03 – Tuesday
 - 04 – Wednesday
 - 05 – Thursday
 - 06 – Friday
 - 07 – Saturday
 - 204 – Interval 2 Holiday Assignment

✓ = Default

- 09 – Holiday 1
 - 10 – Holiday 2
 - 11 – Holiday 3
 - 12 – Holiday 4
 - 301 – Interval 3 Start Time (0000)
 - 302 – Interval 3 End Time (0000)
 - 303 – Interval 3 Days Assignment
 - 01 – Sunday
 - 02 – Monday
 - 03 – Tuesday
 - 04 – Wednesday
 - 05 – Thursday
 - 06 – Friday
 - 07 – Saturday
 - 304 – Interval 3 Holiday Assignment
 - 09 – Holiday 1
 - 10 – Holiday 2
 - 11 – Holiday 3
 - 12 – Holiday 4 201 – Interval 2 Start Time (0000)
 - 402 – Interval 4 End Time (0000)
 - 403 – Interval 4 Days Assignment
 - 01 – Sunday
 - 02 – Monday
 - 03 – Tuesday
 - 04 – Wednesday
 - 05 – Thursday
 - 06 – Friday
 - 07 – Saturday
 - 404 – Interval 4 Holiday Assignment
 - 09 – Holiday 1
 - 10 – Holiday 2
 - 11 – Holiday 3
 - 12 – Holiday 4
- 711-714 Holiday Group 1-4**
- 001 – 099 Holiday Group 1-4 Date 1-99 (000000, MMDDYY)
- Audio Station Programming**
- 802 Audio Station Assignment**
- 001 - 128 – Station Assignment 1 - 128 (00)
 - 600 – 2-Way Audio Trigger Option 1
 - 01 – Tamper
 - 03 – [A] Key Alarm ✓
 - 04 – [P] Key Alarm ✓
 - 05 – Duress Alarm ✓
 - 06 – Opening After Alarm ✓
 - 07 – Future Use
 - 08 – Zone Supervision Alarm
 - 603 – 2-Way Audio Control Option 1
 - 01 – Future Use
 - 02 – Listen to all zones / Listen to zones in alarm ✓
 - 03 – Future Use
 - 04 – Siren Active During 2-Way Audio
 - 05 – Hang-Up Auto Detection
 - 06 – User Call-In
 - 07 – Future Use
 - 08 – 2-Way Audio Initiated by CS
 - 605 – Record Options
 - 01 – Audio Capture Enable ✓

- 02 – Erase on FTC
- 606 – Audio Station Record Control Option 1
 - 01 – Audio Station 1 Record ✓
 - 02 – Audio Station 2 Record ✓
 - 03 – Audio Station 3 Record ✓
 - 04 – Audio Station 4 Record ✓
- 610 – Call Back / Recovery Window Duration (05)
- 611 – Call Back Acknowledge code (9999)
- 612 – Answering Machine Bypass (00)
- 613 – Double Call Timer (030)
- 614 – Number of Rings to Answer (00)
- 615 – Audio Duration (90 sec.)
- 616 – Record Time (105 sec.)
- 617 – Erase Timer (15 min.)
- 606 – Audio Station Tamper Option 1
 - 01 – Audio Station 1 Tamper
 - 02 – Audio Station 2 Tamper
 - 03 – Audio Station 3 Tamper
 - 04 – Audio Station 4 Tamper

Wireless Programming

804 Wireless Programming

- 000 – WLS Device Enrollment Zones (3-digit decimal)
- Zone Type (2-digit decimal)
- Partition Assignment
- Zone Label (LCD only)
- WLS Keys
- Partition Assignment
- User Assignment
- Sirens
- Partition Assignment
- Siren Label (LCD only)
- Keypads
- Keypad Assignment
- Keypad Label (LCD only)
- Repeaters
- Repeater Label (LCD only)
- 001 - 128 – Configure Wireless Zones

Refer to the installation instructions provided with the HSM2Host for more wireless programming options.

850 Cellular Signal Strength

851 Alternate Communicator Programming

Refer to the installation instructions provided with the alternate communicator for details.

Keypad Programming

860 Keypad Slot Number

861-876 Keypad Programming

- 000 – Keypad Partition Mask
- 00 – Global Keypad
- 01 – Partition 1 ✓

- 02 – Partition 2
- 03 – Partition 3
- 04 – Partition 4
- 05 – Partition 5
- 06 – Partition 6
- 07 – Partition 7
- 08 – Partition 8
- 001 – Function Key 1 (03)
- 002 – Function Key 2 (04)
- 003 – Function Key 3 (06)
- 004 – Function Key 4 (22)
- 005 – Function Key 5 (16)
- 00 – Null Key
- 02 – Instant Stay Arm
- 03 – Stay Arm
- 04 – Away Arm
- 05 – No Entry Arm
- 06 – Chime On/Off
- 07 – System Test
- 09 – Night Arm
- 12 – Global Stay Arm
- 13 – Global Away Arm
- 14 – Global Disarming
- 16 – Quick Exit
- 17 – Arm Interior
- 21-24 – Command Output 1-4
- 29 – Bypass Group Recall
- 31 – Local PGM Activate
- 32 – Bypass Mode
- 33 – Bypass recall
- 34 – User Programming
- 35 – User Functions
- 37 – Time/Date Programming
- 39 – Trouble Display
- 40 – Alarm Memory
- 61-68 – Partition Select 1-8

011 – Keypad I/O (000)

012 – Local PGM Output Timer

- Pulse Time (00 minutes)
- Pulse Time (05 sec.)

021 – Keypad Option 1

- 1 – [F] Key Enabled ✓
- 2 – [M] Key Enabled ✓
- 3 – [P] Key Enabled ✓
- 4 – Display Code or X's ✓

022 – Keypad Option 2

- 1 – Local Clock Display ✓
- 2 – Local Clock Display 24 Hour
- 3 – Auto Alarm Scroll ✓
- 5 – Power LED Option ✓
- 6 – Power LED AC Present ✓
- 7 – Alarms Displayed if Armed ✓
- 8 – Auto Scroll Open Zones ✓

023 – Keypad Option 3

- 1 – Armed LED Power Save*
- 2 – Keypad Show Arm Mode ✓*
- 3 – 5th Terminal is PGM Output/Zone
- 7 – Local Display of Temp.
- 8 – Low Temperature Warning

030 – LCD Message (16 x 2 hex)

031 – Download LCD Message Duration (000)

041 – Indoor Temperature Zone Entry (000)

042 – Outdoor Temperature Zone Entry (000)

101-228 – Door Chime Sound-Zone 1-128

- 00 – Disabled
- 01 – 6 beeps ✓
- 02 – "Bing-Bing" Sound
- 03 – "Ding-Dong" Sound
- 04 – Alarm Tone
- 05 – Zone Name

899 Template Programming

- 5-Digit Template Code (5-digit decimal)
- Central Station Telephone Number (32-digit decimal)
- Central Station Account Code (4/6-digit decimal)
- Partition Account Code (4-digit decimal)
- DLS Access Code (6-digit decimal)
- Partition Entry Delay (000-255 sec.)
- Partition Exit Delay (000-255 sec.)
- Installer Code

System Information and

Testing

900 System Information

- 000 – Control Panel Version
- 001- 016 – Keypad 1-16 Version Info
- 101-116 – 8-HSM2108 1-16 Version Info
- 201-216 – HSM2208 Version Information
- 460 – Alternate Communicator
- 461 – HSM2HOST Version Info
- 481 – HSM2955 Version Info
- 501 – 504 HSM2300 1-4 Version Info
- 521 – 524 HSM2204 1-4 Version Info

901 Installer Walk Test

Module Programming

902 Add/Remove Modules

- 000 – Auto-Enroll All Modules
- 001 – Enroll Modules
- 002 – Slot Assignment
- 003 – Edit Module Slot Assignment
- 101 – Delete Keypads
- 102 – Delete HSM2108
- 103 – Delete HSM2208
- 106 – Delete HSM2HOST
- 108 – Delete HSM2955
- 109 – Delete HSM2300
- 110 – Delete HSM2204

903 Confirm Modules

- 000 – View All Modules
- 101 – Keypads
- 102 – HSM2108
- 103 – HSM2208
- 106 – HSM2HOST
- 108 – Confirm HSM2955
- 109 – HSM2300
- 110 – HSM2204

904 Wireless Placement Test

- 001-128 – Placement Test Zones 1-128

✓ = Default

521-528 – Placement Test

Repeaters 1-28

551-566 – Placement Test Sirens
1-16

601-632 – Placement Test

Wireless Keys 1-32

701-716 – Placement Test

Wireless Keypads 1-16

912 Soak Test

000 – Zone Soak Test Duration

Default: 014):

001-128 – Zone Soak Test - Zones

1-128

Battery Settings

982 Battery Settings

000– Panel Battery Settings

01– Panel High Charge

Current

010 – HSM2204 Battery Settings

01 – HSM2204 1 High Charge

Current

02 – HSM2204 2 High Charge

Current

03 – HSM2204 3 High Charge

Current

04 – HSM2204 4 High Charge

Current

020 – HSM2300 Battery Settings

01 – HSM2300 1 Charge

02 – HSM2300 2 Charge

03 – HSM2300 3 Charge

04 – HSM2300 4 Charge

Defaults

989 Default Master Code

990 Installer Lockout Enable/Disable

991 Default Keypads

901-916 – Default Keypad 1-16

999 – Default all Keypads

993 Default Alt Comm

996 Default HSM2HOST

998 Default HSM2955

999 Default System

* Wireless keypads only

IMPORTANT – READ CAREFULLY: DSC Software purchased with or without Products and Components is copyrighted and is purchased under the following license terms:

This End-User License Agreement ("EULA") is a legal agreement between You (the company, individual or entity who acquired the Software and any related Hardware) and Digital Security Controls, a division of Tyco Safety Products Canada Ltd. ("DSC"), the manufacturer of the integrated security systems and the developer of the software and any related products or components ("HARDWARE") which You acquired.

If the DSC software product ("SOFTWARE PRODUCT" or "SOFTWARE") is intended to be accompanied by HARDWARE, and is NOT accompanied by new HARDWARE, You may not use, copy or install the SOFTWARE PRODUCT. The SOFTWARE PRODUCT includes computer software, and may include associated media, printed materials, and "online" or electronic documentation.

Any software provided along with the SOFTWARE PRODUCT that is associated with a separate end-user license agreement is licensed to You under the terms of that license agreement.

By installing, copying, downloading, storing, accessing or otherwise using the SOFTWARE PRODUCT, You agree unconditionally to be bound by the terms of this EULA, even if this EULA is deemed to be a modification of any previous arrangement or contract. If You do not agree to the terms of this EULA, DSC is unwilling to license the SOFTWARE PRODUCT to You, and You have no right to use it.

SOFTWARE PRODUCT LICENSE

The SOFTWARE PRODUCT is protected by copyright laws and international copyright treaties, as well as other intellectual property laws and treaties. The SOFTWARE PRODUCT is licensed, not sold.

1. GRANT OF LICENSE This EULA grants You the following rights:

(a) Software Installation and Use - For each license You acquire, You may have only one copy of the SOFTWARE PRODUCT installed.

(b) Storage/Network Use - The SOFTWARE PRODUCT may not be installed, accessed, displayed, run, shared or used concurrently on or from different computers, including a workstation, terminal or other digital electronic device ("Device"). In other words, if You have several workstations, You will have to acquire a license for each workstation where the SOFTWARE will be used.

(c) Backup Copy - You may make back-up copies of the SOFTWARE PRODUCT, but You may only have one copy per license installed at any given time. You may use the back-up copy solely for archival purposes. Except as expressly provided in this EULA, You may not otherwise make copies of the SOFTWARE PRODUCT, including the printed materials accompanying the SOFTWARE.

2. DESCRIPTION OF OTHER RIGHTS AND LIMITATIONS

(a) Limitations on Reverse Engineering, Decompilation and Disassembly - You may not reverse engineer, decompile, or disassemble the SOFTWARE PRODUCT, except and only to the extent that such activity is expressly permitted by applicable law notwithstanding this limitation. You may not make any changes or modifications to the Software, without the written permission of an officer of DSC. You may not remove any proprietary notices, marks or labels from the Software Product. You shall institute reasonable measures to ensure compliance with the terms and conditions of this EULA.

(b) Separation of Components - The SOFTWARE PRODUCT is licensed as a single product. Its component parts may not be separated for use on more than one HARDWARE unit.

(c) Single INTEGRATED PRODUCT - If You acquired this SOFTWARE with HARDWARE, then the SOFTWARE PRODUCT is licensed with the HARDWARE as a single integrated product. In this case, the SOFTWARE PRODUCT may only be used with the HARDWARE as set forth in this EULA.

(d) Rental - You may not rent, lease or lend the SOFTWARE PRODUCT. You may not make it available to others or post it on a server or web site.

(e) Software Product Transfer - You may transfer all of Your rights under this EULA only as part of a permanent sale or transfer of the HARDWARE, provided You retain no copies, You transfer all of the SOFTWARE PRODUCT (including all component parts, the media and printed materials, any upgrades and this EULA), and provided the recipient agrees to the terms of this EULA. If the SOFTWARE PRODUCT is an upgrade, any transfer must also include all prior versions of the SOFTWARE PRODUCT.

(f) Termination - Without prejudice to any other rights, DSC may terminate this EULA if You fail to comply with the terms and conditions of this EULA. In such event, You must destroy all copies of the SOFTWARE PRODUCT and all of its component parts.

(g) Trademarks - This EULA does not grant You any rights in connection with any trademarks or service marks of DSC or its suppliers.

3. COPYRIGHT - All title and intellectual property rights in and to the SOFTWARE PRODUCT (including but not limited to any images, photographs, and text incorporated into the SOFTWARE PRODUCT), the accompanying printed materials, and any copies of the SOFTWARE PRODUCT, are owned by DSC or its suppliers. You may not copy the printed materials accompanying the SOFTWARE PRODUCT. All title and intellectual property rights in and to the content which may be accessed through use of the SOFTWARE PRODUCT are the property of the respective content owner and may be protected by applicable copyright or other intellectual property laws and treaties. This EULA grants You no rights to use such content. All rights not expressly granted under this EULA are reserved by DSC and its suppliers.

4. EXPORT RESTRICTIONS - You agree that You will not export or re-export the SOFTWARE PRODUCT to any country, person, or entity subject to Canadian export restrictions.

5. CHOICE OF LAW - This Software License Agreement is governed by the laws of the Province of Ontario, Canada.

6. ARBITRATION - All disputes arising in connection with this Agreement shall be determined by final and binding arbitration in accordance with the Arbitration Act, and the parties agree to be bound by the arbitrator's decision. The place of arbitration shall be Toronto, Canada, and the installation manual of the arbitration shall be English.

7. LIMITED WARRANTY

(a) NO WARRANTY - DSC PROVIDES THE SOFTWARE "AS IS" WITHOUT WARRANTY. DSC DOES NOT WARRANT THAT THE SOFTWARE WILL MEET YOUR REQUIREMENTS OR THAT OPERATION

OF THE SOFTWARE WILL BE UNINTERRUPTED OR ERROR-FREE.

(b) CHANGES IN OPERATING ENVIRONMENT - DSC shall not be responsible for problems caused by changes in the operating characteristics of the HARDWARE, or for problems in the interaction of the SOFTWARE PRODUCT with non-DSC-SOFTWARE or HARDWARE PRODUCTS.

(c) LIMITATION OF LIABILITY; WARRANTY REFLECTS ALLOCATION OF RISK - IN ANY EVENT, IF ANY STATUTE IMPLIES WARRANTIES OR CONDITIONS NOT STATED IN THIS LICENSE AGREEMENT, DSC'S ENTIRE LIABILITY UNDER ANY PROVISION OF THIS LICENSE AGREEMENT SHALL BE LIMITED TO THE GREATER OF THE AMOUNT ACTUALLY PAID BY YOU TO LICENSE THE SOFTWARE PRODUCT AND FIVE CANADIAN DOLLARS (CAD\$5.00). BECAUSE SOME JURISDICTIONS DO NOT ALLOW THE EXCLUSION OR LIMITATION OF LIABILITY FOR CONSEQUENTIAL OR INCIDENTAL DAMAGES, THE ABOVE LIMITATION MAY NOT APPLY TO YOU.

(d) DISCLAIMER OF WARRANTIES - THIS WARRANTY CONTAINS THE ENTIRE WARRANTY AND SHALL BE IN LIEU OF ANY AND ALL OTHER WARRANTIES, WHETHER EXPRESSED OR IMPLIED (INCLUDING ALL IMPLIED WARRANTIES OF MERCHANTABILITY OR FITNESS FOR A PARTICULAR PURPOSE) AND OF ALL OTHER OBLIGATIONS OR LIABILITIES ON THE PART OF DSC. DSC MAKES NO OTHER WARRANTIES. DSC NEITHER ASSUMES NOR AUTHORIZES ANY OTHER PERSON PURPORTING TO ACT ON ITS BEHALF TO MODIFY OR TO CHANGE THIS WARRANTY, NOR TO ASSUME FOR IT ANY OTHER WARRANTY OR LIABILITY CONCERNING THIS SOFTWARE PRODUCT.

(e) EXCLUSIVE REMEDY AND LIMITATION OF WARRANTY - UNDER NO CIRCUMSTANCES SHALL DSC BE LIABLE FOR ANY SPECIAL, INCIDENTAL, CONSEQUENTIAL OR INDIRECT DAMAGES BASED UPON BREACH OF WARRANTY, BREACH OF CONTRACT, NEGLIGENCE, STRICT LIABILITY, OR ANY OTHER LEGAL THEORY. SUCH DAMAGES INCLUDE, BUT ARE NOT LIMITED TO, LOSS OF PROFITS, LOSS OF THE SOFTWARE PRODUCT OR ANY ASSOCIATED EQUIPMENT, COST OF CAPITAL, COST OF SUBSTITUTE OR REPLACEMENT EQUIPMENT, FACILITIES OR SERVICES, DOWNTIME, PURCHASERS TIME, THE CLAIMS OF THIRD PARTIES, INCLUDING CUSTOMERS, AND INJURY TO PROPERTY.

WARNING: DSC recommends that the entire system be completely tested on a regular basis. However, despite frequent testing, and due to, but not limited to, criminal tampering or electrical disruption, it is possible for this SOFTWARE PRODUCT to fail to perform as expected.

Regulatory Approvals

FCC COMPLIANCE STATEMENT

CAUTION: Changes or modifications not expressly approved by Digital Security Controls could void your authority to use this equipment.

This equipment has been tested and found to comply with the limits for a Class B digital device, pursuant to Part 15 of the FCC Rules. These limits are designed to provide reasonable protection against harmful interference in a residential installation. This equipment generates, uses and can radiate radio frequency energy and, if not installed and used in accordance with the instructions, may cause harmful interference to radio communications. However, there is no guarantee that interference will not occur in a particular installation. If this equipment does cause harmful interference to radio or television reception, which can be determined by turning the equipment off and on, the user is encouraged to try to correct the interference by one or more of the following measures:

- Re-orient the receiving antenna.
- Increase the separation between the equipment and receiver.
- Connect the equipment into an outlet on a circuit different from that to which the receiver is connected.
- Consult the dealer or an experienced radio/television technician for help.

The user may find the following booklet prepared by the FCC useful: "How to Identify and Resolve Radio/Television Interference Problems". This booklet is available from the U.S. Government Printing Office, Washington D.C. 20402, Stock # 004-000-00345-4.

IMPORTANT INFORMATION

This equipment complies with Part 68 of the FCC Rules. On the side of this equipment is a label that contains, among other information, the FCC registration number and ringer equivalence number (REN) for this equipment. If requested, this number must be provided to the Telephone Company.

HS2128 Product Identifier US: F53AL01BHS2128

REN: 0.1B

USOC Jack: RJ-31X

Telephone Connection Requirements

A plug and jack used to connect this equipment to the premises wiring and telephone network must comply with the applicable FCC Part 68 rules and requirements adopted by the ACTA. A compliant telephone cord and modular plug is provided with this product. It is designed to be connected to a compatible modular jack that is also compliant. See installation instructions for details.

Ringer Equivalence Number (REN)

The REN is used to determine the number of devices that may be connected to a telephone line. Excessive RENs on a telephone line may result in the devices not ringing in response to an incoming call. In most but not all areas, the sum of RENs should not exceed five (5.0). To be certain of the number of devices that may be connected to a line, as determined by the total RENs, contact the local Telephone Company. For products approved after July 23, 2001, the REN for this product is part of the product identifier that has the format.

US: AAAEQ##TXXXX. The digits represented by ## are the REN without a decimal point (e.g., 03 is a REN of 0.3). For earlier products, the REN is separately shown on the label.

Incidence of Harm

If this equipment HS2016/HS2032/HS2064/HAS2128 causes harm to the telephone network, the telephone company will notify you in advance that temporary discontinuance of service may be required. But if advance notice is not practical, the Telephone Company will notify the customer as soon as possible. Also, you will be advised of your right to file a complaint with the FCC if you believe it is necessary.

Changes in Telephone Company Equipment or Facilities

The Telephone Company may make changes in its facilities, equipment, operations or procedures that could affect the operation of the equipment. If this happens the Telephone Company will provide advance notice in order for you to make necessary modifications to maintain uninterrupted service.

Equipment Maintenance Facility

If trouble is experienced with this equipment HS2016/HS2032/HS2064/HAS21284 for repair or warranty information, please contact the facility indicated below. If the equipment is causing harm to the telephone network, the Telephone Company may request that you disconnect the equipment until the problem is solved. This equipment is of a type that is not intended to be repaired by the end user.

DSC c/o APL Logistics, 757 Douglas Hill Rd., Lithia Springs, GA 30122

Additional Information

Connection to party line service is subject to state tariffs. Contact the state public utility commission, public service commission or corporation commission for information.

Alarm dialling equipment must be able to seize the telephone line and place a call in an emergency situation. It must be able to do this even if other equipment (telephone, answering system, computer modem, etc.) already has the telephone line in use. To do so, alarm dialling equipment must be connected to a properly installed RJ-31X jack that is electrically in series with and ahead of all other equipment attached to the same telephone line. Proper installation is depicted in the figure below. If you have any questions concerning these instructions, you should consult your telephone company or a qualified installer about installing the RJ-31X jack and alarm dialling equipment for you.

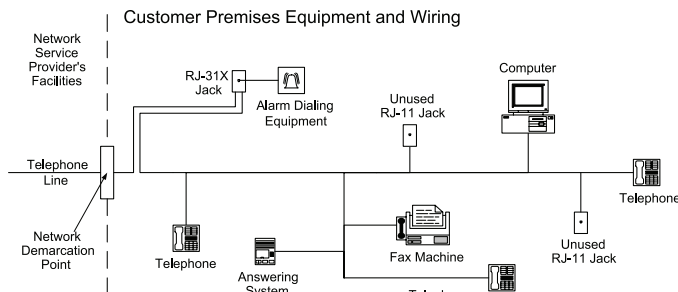

INDUSTRY CANADA STATEMENT

NOTICE: This Equipment, HS2016/HS2032/HS2064/HAS2128, meets the applicable Industry Canada Terminal Equipment Technical Specifications. This is confirmed by the registration number. The abbreviation, IC, before the registration number signifies that registration was performed based on a Declaration of Conformity indicating that Industry Canada technical specifications were met. It does not imply that Industry Canada approved the equipment

NOTICE: The Ringer Equivalence Number (REN) for this terminal equipment is 0.1. The REN assigned to each terminal equipment provides an indication of the maximum number of terminals allowed to be connected to a telephone interface. The termination on an interface may consist of any combination of devices subject only to the requirement that the sum of the Ringer Equivalence Numbers of all devices does not exceed five.

L'indice d'équivalence de la sonnerie (IES) sert à indiquer le nombre maximal de terminaux qui peuvent être raccordés à une interface téléphonique. La terminaison d'une interface peut consister en une combinaison quelconque de dispositifs, à la seule condition que la somme d'indices d'équivalence de la sonnerie de tous les dispositifs n'exécède pas 5.

Certification Number:

IC: 160A-HS2128

This Class B digital apparatus complies with Canadian ICES-003.

Cet appareil numérique de la classe B est conforme à la norme NMB-003 du Canada.

UL/ULC Installations

This product has been tested and found in compliance with the following standards:

- UL1610 Central-Station Burglar-Alarm Units
- UL365 Police Station Connected Burglar Alarm Units and Systems
- UL1023 Household Burglar-Alarm System Units
- UL985 Household Fire Warning System Units
- UL1635 Digital Alarm Communicator System Units
- UL1637 Home Health Care Signaling Equipment
- ULC-S304-06 Signal Receiving Centre & Premise Burglar Alarm Control Units
- ULC-S559-04 Equipment for Fire Signal Receiving Centers and Systems
- ULC-S545-02 Residential Fire Warning System Control Units
- ORD-C1023-1974 Household Burglar-Alarm System Units

This product has also been tested and found in compliance with the ANSI/SIA CP-01-2010 Control Panel Standard – Features for False Alarm Reduction.

This product is UL/ULC listed under the following categories:

- AMCX/AMCXC Central Stations Alarm Units
- APAW Police-station-connected Alarm Units
- DAYRC Central Station Fire Alarm System Units
- UTOU/UTOCU Control Units and Accessories, Household System Type
- NBSX/NBSXC Household Burglar Alarm System Units
- AMTB Control Panels, SIA False Alarm Reduction

The product is labeled with the UL and ULC listing marks along with the SIA CP-01 compliance statement (Also Classified in accordance with SIA-CP-01 Standard) as proof of compliance with the above mentioned standards. For further information on this product's listings please also refer to the official listing guides published at the UL web site (www.ul.com) under Online Directions Section.

UL/ULC Residential Fire and Burglary Installations:

For ULC Installations refer to the Standard for the Installation of Residential Fire Warning Systems, CAN/ULC-S540.

- All burglary-type zones shall be configured with SEOL or DEOL configuration. Use model EOLR-2.
- (refer to section [002], bit 10 or 11 shall be ON)
- Use at least one PG9926 or PG9916 Smoke Detector for Fire Installations (section [001], fire zone shall be programmed as type 025)
- The entry delay shall not exceed 45 seconds (refer to section [005])
- The exit delay shall not exceed 60 seconds (refer to section [005])
- The minimum Bell Time-out is 4 minutes (refer to section [005])

Note: For ULC Residential Fire Installations the minimum Bell Time-out is 5 minutes

For UL Home Health Care Installations the minimum Bell Time-out is 5 min.

For UL Commercial Burglary Installations minimum Bell Time-out is 15 min.

- Temporal Three Fire Signal shall be enabled (section [013], opt.8 ON)
- Arm/Disarm Bell Squawk shall be enabled when using wireless key PG4939, PG4929, PG4949 (section [014], option 1 shall be ON)
- A code shall be required for bypassing (section [023], option 4 shall be ON)
- Trouble beeps shall be enabled (section [022], option 7 shall be ON)
- AC trouble indication LED shall be enabled (Keypad Programming, section [022], options 5 and 6 shall be ON)
- DACT Communicator shall be enabled for Supervising Station Monitoring (section [380], option 1 shall be ON)

Note: The DACT communicator for this product has no line security.

- Telephone Line Monitoring (TLM) shall be enabled (section [015], option 7 shall be ON)

Note: This product is programmed to perform 5 (min.) to 10 (max.) attempts for communication of an event to the supervising station. If unsuccessful, a Fail To Communicate (FTC) trouble is generated.

- Test transmission cycle shall be set for monthly transmission (refer to section [351])

Note: For ULC Residential/Commercial installations set for daily test transmission

- Wireless Supervision window shall be set to 4 hours for Fire Installations (Wireless Programming, section [804]-[802] shall be programmed with the value 16)
- Wireless Supervision window shall be set to 4 hours for Burglary Installations only (Wireless Programming, section [804]-[802] shall be programmed with the value 96)
- RF Jam detection shall be enabled (refer to Wireless Programming (section [804][801], option 00 shall be OFF)
- New Alarms will Disconnect 2-way Audio (section [022], opt 6 OFF)

UL Central Station and Police Connect with Standard or Encrypted Line Security Service

- The installation must use the Models TL2803G(R) IP/3G Interface, 3G2080(R) 3G Interface or TL280(R) IP Interface, which communicates over Cellular Data Network or an Ethernet network 10/100BaseT to the compatible Sur-Gard System I/II/III/IV receiver.
- Polling time shall be 200 seconds and compromise detection time shall be 6 min.
- For Encrypted line security applications, the Models TL2803G(R) IP/3G Interface, 3G2080(R) 3G Interface or TL280(R) IP Interface shall have the Encryption Key enabled (AES128 bit encryption algorithm is validated under NIST Certificate No.2645)
- Wireless Supervision window shall be enabled (refer to Wireless Programming, sections [804]-[802])

UL Local, Central Station and Police Connect with No Line Security Service

- The installation shall use a Bell which is UL Listed for Mercantile local alarms. An example of a UL Listed bell that can be used is Amseco Model MBL10B bell with Model AB-12 bell housing. Connections from the control unit to the bell shall be made in conduit. (Optional for central Station)
- The bell timeout shall be programmed for 15 minutes minimum
- At least one system remote keypad with tamper switch shall be employed
- The integral DACT shall be enabled and shall be programmed to provide a low battery transmission
- The control panel shall be in the attack resistant enclosure. The separately listed CMC-1 or PC4050CA attack resistant enclosure shall be employed
- The maximum entry delay time shall not exceed 45s as a result of the attack test. The maximum exit delay time shall not exceed 60 s.
- A tamper switch shall be used to protect the enclosure cover of the control unit. A tamper switch shall also be used on the keypad rear to detect removal from the wall.
- 24 h check in transmission shall be enabled
- Open/Closing acknowledgement enabled.(Not Police Station)

- The Installation shall use the internal dialer (DACT) alone or in conjunction with Models TL2803G(R) IP/3G Interface, 3G2080(R) 3G Interface or TL280(R) IP Interface, which communicates over Cellular Data Network or an Ethernet network 10/100BaseT to the compatible Sur-Gard System I/II/III/IV receiver.

UL Home Health Care Signaling Equipment

- There must be at least two keypads, one of either one of the compatible keypads models HS2LED, HS2LCD(P), HS2ICN(P), HS2LCDRF(P)9, HS2ICNRF(P)9 and HS2TCHP
- Each system shall be programmed to activate an audible Trouble signal within 90 seconds upon loss of microprocessor memory
- The HS2TCHP shall be used along with another compatible model keypad in order to provide audible supervision for homehealth care or medical installations.

ULC Central Station Fire and Burglary Monitoring Installations

- For installation requirements, levels of security, communication modules and configurations (Refer to the ULC Installation Information Sheet, DSC #29002157)
- Use a CSA/cUL approved transformer (hardwired connections required for Fire Monitoring)
- All tamper circuits may be connected to the same zone
- HS2TCHP touch screen keypad is for supplementary use only with ULC Commercial Fire Monitoring

Programming

The notes in the programming sections of the PowerSeries Neo Reference Manual describing the system configurations for UL/ULC listed installations shall be implemented.

Control of the Protected Premises

In order to have a UL certificated system, the protected area is to be under the responsibility of one ownership and management (i.e., one business under one name). This may be a group of buildings attached or unattached with different addresses but under the responsibility of someone having mutual interest. The person of mutual interest is not the alarm-installing company.

Note: This does not apply to strip mall applications where each independent business must have their own separate alarm system.

e.g.,1: a commercial partitioned system that has an office and a warehouse area in a building where each area can be armed or disarmed independently.

e.g.,2: a residential system partitioned so that the garage area is armed separately from the house.

Each of the above examples is under the sole responsibility of a single owner. The bell and DACT power supply must be in a protected area including partitioned systems. The bell and DACT power supply must be located where it can be heard by the person or persons responsible for maintaining the security system during the daily arming cycle.

Bell Location

The alarm sounding device (bell) shall be located where it can be heard by the person operating the security system during the daily arming and disarming cycle.

Protection of the Control Unit

- The local control unit and the local power supply must be protected in one of the following ways:
- The control unit and audible alarm device must be in a protected area which is armed 24 hours a day.
- Each partition must arm the area protecting the control unit and the audible alarm device power supply. This may require duplicate protection armed by each partition. Access to this protected area, without causing an alarm, will require that all partitions be disarmed.
- In all cases described above, the protected area for the control unit must be programmed as not-bypassable.

Casual Users

The installer should caution the user(s) not to give system information (e.g., codes, bypass methods, etc.) to casual users (baby-sitters or service people). Only the One-Time Use codes shall be given to casual users.

User Information

The installer should advise the users and note in the User's Manual:

- Service organization name and telephone number
- The programmed exit time
- The programmed entry time
- Test system weekly
- The installer code cannot arm or disarm the system

Zone Record

| Zone | Label | Location | Type | Attribute | Zone | Label | Location | Type | Attribute |
|------|-------|----------|------|-----------|------|-------|----------|------|-----------|
| 001 | | | | | 002 | | | | |
| 003 | | | | | 004 | | | | |
| 005 | | | | | 006 | | | | |
| 007 | | | | | 008 | | | | |
| 009 | | | | | 010 | | | | |
| 011 | | | | | 012 | | | | |
| 013 | | | | | 014 | | | | |
| 015 | | | | | 016 | | | | |
| 017 | | | | | 018 | | | | |
| 019 | | | | | 020 | | | | |
| 021 | | | | | 022 | | | | |
| 023 | | | | | 024 | | | | |
| 025 | | | | | 026 | | | | |
| 027 | | | | | 028 | | | | |
| 029 | | | | | 030 | | | | |
| 031 | | | | | 032 | | | | |
| 033 | | | | | 034 | | | | |
| 035 | | | | | 036 | | | | |
| 037 | | | | | 038 | | | | |
| 039 | | | | | 040 | | | | |
| 041 | | | | | 042 | | | | |
| 043 | | | | | 044 | | | | |
| 045 | | | | | 046 | | | | |
| 047 | | | | | 048 | | | | |
| 049 | | | | | 050 | | | | |
| 051 | | | | | 052 | | | | |
| 053 | | | | | 054 | | | | |
| 055 | | | | | 056 | | | | |
| 057 | | | | | 058 | | | | |
| 059 | | | | | 060 | | | | |
| 061 | | | | | 062 | | | | |
| 063 | | | | | 064 | | | | |
| 065 | | | | | 066 | | | | |
| 067 | | | | | 068 | | | | |
| 069 | | | | | 070 | | | | |
| 071 | | | | | 072 | | | | |
| 073 | | | | | 074 | | | | |
| 075 | | | | | 076 | | | | |
| 077 | | | | | 078 | | | | |
| 079 | | | | | 080 | | | | |
| 081 | | | | | 082 | | | | |
| 083 | | | | | 084 | | | | |
| 085 | | | | | 086 | | | | |
| 087 | | | | | 088 | | | | |
| 089 | | | | | 090 | | | | |
| 091 | | | | | 092 | | | | |
| 093 | | | | | 094 | | | | |
| 095 | | | | | 096 | | | | |
| 097 | | | | | 098 | | | | |

Installer-Defined Access Codes

| | |
|-------------------------|--|
| 001 – Installer Code: | |
| 002 – Master Code: | |
| 003 – Maintenance Code: | |

System Account Code

| |
|--|
| |
|--|

Aux Loading and Battery Selection

| | | | | | |
|--|--|--------------------|--|---|---|
| HS2128/HS2064/ HS2032/HS2016 Board current draw 85mA | UL Residential Burg ULC Residential Burg | UL Commercial Burg | UL Resi Fire UL Home Health Care ULC Resi Fire ULC Com Burg | ULC Fire Monitoring | EN50131 Grade 2/Class II |
| Max AUX (NSC) current loading | 0.7A | 0.7A | 0.5A | 0.5A | 0.5A |
| Max BELL (Alarm) current loading | 0.7A | 0.7A | 0.7A | 0.7A (no local alarm notification allowed, only remote transmission to SRC) | 0.7A |
| UL/ULC Listed enclosure | PC500C PC5003C | CMC-1 PC4050CAR | PC5003C | PC5003C PC4050CR (red/transformer mounted inside) | PC5003C Power UC1 |
| Transformer requirements | 16.5V/40VA (plug in type) PTC1640U (USA) PTC1640CG (CAN) | | | FTC1637 (cUL listed) 16.5V/37VA (Hardwired type, mounted inside the enclosure or outside using electrical box) | 16.5V/40VA (hardwired type, mounted inside the cabinet) |
| Battery Capacity requirements | 7Ah | 7Ah | 14Ah (2 x 7Ah in parallel) | 14Ah (2 x 7Ah in parallel) | 7Ah |
| Standby Time | 4 hours | 4 hours | 24 hours | 24 hours | 12 hours |
| Alarm time | 4 minutes | 15 minutes | 4 min (UL resi fire) 5 min (Home Health Care and ULC Resi Fire) | 5 minutes (Alarm Transmission only) | N/A |
| Recharging current setting | 400mA, 700mA | 400mA, 700mA | 400mA, 700mA | 400mA, 700mA | 400mA, 700mA |

Smoke Detectors

Limited Warranty

Digital Security Controls warrants the original purchaser that for a period of twelve months from the date of purchase, the product shall be free of defects in materials and workmanship under normal use. During the warranty period, Digital Security Controls shall, at its option, repair or replace any defective product upon return of the product to its factory, at no charge for labour and materials. Any replacement and/or repaired parts are warranted for the remainder of the original warranty or ninety (90) days, whichever is longer. The original purchaser must promptly notify Digital Security Controls in writing that there is defect in material or workmanship, such written notice to be received in all events prior to expiration of the warranty period. There is absolutely no warranty on software and all software products are sold as a user license under the terms of the software license agreement included with the product. The Customer assumes all responsibility for the proper selection, installation, operation and maintenance of any products purchased from DSC. Custom products are only warranted to the extent that they do not function upon delivery. In such cases, DSC can replace or credit at its option.

International Warranty

The warranty for international customers is the same as for any customer within Canada and the United States, with the exception that Digital Security Controls shall not be responsible for any customs fees, taxes, or VAT that may be due.

Warranty Procedure

To obtain service under this warranty, please return the item(s) in question to the point of purchase. All authorized distributors and dealers have a warranty program. Anyone returning goods to Digital Security Controls must first obtain an authorization number. Digital Security Controls will not accept any shipment whatsoever for which prior authorization has not been obtained.

Conditions to Void Warranty

This warranty applies only to defects in parts and workmanship relating to normal use. It does not cover:

- damage incurred in shipping or handling;
- damage caused by disaster such as fire, flood, wind, earthquake or lightning;
- damage due to causes beyond the control of Digital Security Controls such as excessive voltage, mechanical shock or water damage;
- damage caused by unauthorized attachment, alterations, modifications or foreign objects;
- damage caused by peripherals (unless such peripherals were supplied by Digital Security Controls Ltd.);
- defects caused by failure to provide a suitable installation environment for the products;
- damage caused by use of the products for purposes other than those for which it was designed;
- damage from improper maintenance;
- damage arising out of any other abuse, mishandling or improper application of the products.

Items Not Covered by Warranty

In addition to the items which void the Warranty, the following items shall not be covered by Warranty: (i) freight cost to the repair centre; (ii) products which are not identified with DSC's product label and lot number or serial number; (iii) products disassembled or repaired in such a manner as to adversely affect performance or prevent adequate inspection or testing to verify any warranty claim. Access cards or tags returned for replacement under warranty will be credited or replaced at DSC's option. Products not covered by this warranty, or otherwise out of warranty due to age, misuse, or damage shall be evaluated, and a repair estimate shall be provided. No repair work will be performed until a valid purchase order is received from the Customer and a Return Merchandise Authorization number (RMA) is issued by DSC's Customer Service.

Digital Security Controls Ltd.'s liability for failure to repair the product under this warranty after a reasonable number of attempts will be limited to a replacement of the product, as the exclusive remedy for breach of warranty. Under no circumstances shall Digital Security Controls be liable for any special, incidental, or consequential damages based upon breach of warranty, breach of contract, negligence, strict liability, or any other legal theory. Such damages include, but are not limited to, loss of profits, loss of the product or any associated equipment, cost of capital, cost of substitute or replacement equipment, facilities or services, down time, purchaser's time, the claims of third parties, including customers, and injury to property. The laws of some jurisdictions limit or do not allow the disclaimer of consequential damages. If the laws of such a jurisdiction apply to any claim by or against DSC, the limitations and

disclaimers contained here shall be to the greatest extent permitted by law. Some states do not allow the exclusion or limitation of incidental or consequential damages, so that the above may not apply to you.

Disclaimer of Warranties

This warranty contains the entire warranty and shall be in lieu of any and all other warranties, whether expressed or implied (including all implied warranties of merchantability or fitness for a particular purpose) and of all other obligations or liabilities on the part of Digital Security Controls. Digital Security Controls neither assumes responsibility for, nor authorizes any other person purporting to act on its behalf to modify or to change this warranty, nor to assume for it any other warranty or liability concerning this product. This disclaimer of warranties and limited warranty are governed by the laws of the province of Ontario, Canada.

WARNING: Digital Security Controls recommends that the entire system be completely tested on a regular basis. However, despite frequent testing, and due to, but not limited to, criminal tampering or electrical disruption, it is possible for this product to fail to perform as expected.

Out of Warranty Repairs

Digital Security Controls will at its option repair or replace out-of-warranty products which are returned to its factory according to the following conditions. Anyone returning goods to Digital Security Controls must first obtain an authorization number. Digital Security Controls will not accept any shipment whatsoever for which prior authorization has not been obtained.

Products which Digital Security Controls determines to be repairable will be repaired and returned. A set fee which Digital Security Controls has predetermined and which may be revised from time to time, will be charged for each unit repaired.

Products which Digital Security Controls determines not to be repairable will be replaced by the nearest equivalent product available at that time. The current market price of the replacement product will be charged for each replacement unit.

WARNING - READ CAREFULLY

Note to Installers

This warning contains vital information. As the only individual in contact with system users, it is your responsibility to bring each item in this warning to the attention of the users of this system.

System Failures

This system has been carefully designed to be as effective as possible. There are circumstances, however, involving fire, burglary, or other types of emergencies where it may not provide protection. Any alarm system of any type may be compromised deliberately or may fail to operate as expected for a variety of reasons. Some but not all of these reasons may be:

Inadequate Installation

A security system must be installed properly in order to provide adequate protection. Every installation should be evaluated by a security professional to ensure that all access points and areas are covered. Locks and latches on windows and doors must be secure and operate as intended. Windows, doors, walls, ceilings and other building materials must be of sufficient strength and construction to provide the level of protection expected. A reevaluation must be done during and after any construction activity. An evaluation by the fire and/or police department is highly recommended if this service is available.

Criminal Knowledge

This system contains security features which were known to be effective at the time of manufacture. It is possible for persons with criminal intent to develop techniques which reduce the effectiveness of these features. It is important that a security system be reviewed periodically to ensure that its features remain effective and that it be updated or replaced if it is found that it does not provide the protection expected.

Access by Intruders

Intruders may enter through an unprotected access point, circumvent a sensing device, evade detection by moving through an area of insufficient coverage, disconnect a warning device, or interfere with or prevent the proper operation of the system.

Power Failure

Control units, intrusion detectors, smoke detectors and many other security devices require an adequate power supply for proper operation. If a device operates from batteries, it is possible for the batteries to fail. Even if the batteries have not failed, they must be charged, in good condition and installed correctly. If a device operates only by AC power, any interruption, however brief, will render that device inoperative while it does not have power. Power interruptions of any length are often accompanied by voltage fluctuations which may damage electronic equipment such as a security system. After a power interruption has occurred, immediately conduct a complete system test to ensure that the system operates as intended.

Failure of Replaceable Batteries

This system's wireless transmitters have been designed to provide several years of battery life under normal conditions. The expected battery life is a function of the device environment, usage and type. Ambient conditions such as high humidity, high or low temperatures, or large temperature fluctuations may reduce the expected battery life. While each transmitting device has a low battery monitor which identifies when the batteries need to be replaced, this monitor may fail to operate as expected. Regular testing and maintenance will keep the system in good operating condition.

Compromise of Radio Frequency (Wireless) Devices

Signals may not reach the receiver under all circumstances which could include metal objects placed on or near the radio path or deliberate jamming or other inadvertent radio signal interference.

System Users

A user may not be able to operate a panic or emergency switch possibly due to permanent or temporary physical disability, inability to reach the device in time, or unfamiliarity with the correct operation. It is important that all system users be trained in the correct operation of the alarm system and that they know how to respond when the system indicates an alarm.

Smoke Detectors

Smoke detectors that are a part of this system may not properly alert occupants of a fire for a number of reasons, some of which follow. The smoke detectors may have been improperly installed or positioned. Smoke may not be able to reach the smoke detectors, such as when the fire is in a chimney, walls or roofs, or on the other side of closed doors. Smoke detectors may not detect smoke from fires on another level of the residence or building.

Every fire is different in the amount of smoke produced and the rate of burning. Smoke detectors cannot sense all types of fires equally well. Smoke detectors may not provide timely warning of fires caused by carelessness or safety hazards such as smoking in bed, violent explosions, escaping gas, improper storage of flammable materials, overloaded electrical circuits, children playing with matches or arson.

Even if the smoke detector operates as intended, there may be circumstances when there is insufficient warning to allow all occupants to escape in time to avoid injury or death.

Motion Detectors

Motion detectors can only detect motion within the designated areas as shown in their respective installation instructions. They cannot discriminate between intruders and intended occupants. Motion detectors do not provide volumetric area protection. They have multiple beams of detection and motion can only be detected in unobstructed areas covered by these beams. They cannot detect motion which occurs behind walls, ceilings, floor, closed doors, glass partitions, glass doors or windows. Any type of tampering whether intentional or unintentional such as masking, painting, or spraying of any material on the lenses, mirrors, windows or any other part of the detection system will impair its proper operation.

Passive infrared motion detectors operate by sensing changes in temperature. However their effectiveness can be reduced when the ambient temperature rises near or above body temperature or if there are intentional or unintentional sources of heat in or near the detection area. Some of these heat sources could be heaters, radiators, stoves, barbecues, fireplaces, sunlight, steam vents, lighting and so on.

Warning Devices

Warning devices such as sirens, bells, horns, or strobes may not warn people or waken someone sleeping if there is an intervening wall or door. If warning devices are located on a different level of the residence or premise, then it is less likely that the occupants will be alerted or awakened. Audible warning devices may be interfered with by other noise sources such as stereos, radios, televisions, air conditioners or other appliances, or passing traffic. Audible warning devices, however loud, may not be heard by a hearing-impaired person.

Telephone Lines

If telephone lines are used to transmit alarms, they may be out of service or busy for certain periods of time. Also an intruder may cut the telephone line or defeat its operation by more sophisticated means which may be difficult to detect.

Insufficient Time

There may be circumstances when the system will operate as intended, yet the occupants will not be protected from the emergency due to their inability to respond to the warnings in a timely manner. If the system is monitored, the response may not occur in time to protect the occupants or their belongings.

Component Failure

Although every effort has been made to make this system as reliable as possible, the system may fail to function as intended due to the failure of a component.

Inadequate Testing

Most problems that would prevent an alarm system from operating as intended can be found by regular testing and maintenance. The complete system should be tested weekly and immediately after a break-in, an attempted break-in, a fire, a storm, an earthquake, an accident, or any kind of construction activity inside or outside the premises. The testing should include all sensing devices, keypads, consoles, alarm indicating devices and any other operational devices that are part of the system.

Security and Insurance

Regardless of its capabilities, an alarm system is not a substitute for property or life insurance. An alarm system also is not a substitute for property owners, renters, or other occupants to act prudently to prevent or minimize the harmful effects of an emergency situation.

IMPORTANT - READ CAREFULLY:

DSC Software purchased with or without Products and Components is copyrighted and is purchased under the following license terms:

- This End-User License Agreement ("EULA") is a legal agreement between You (the company, individual or entity who acquired the Software and any related Hardware) and Digital Security Controls, a division of Tyco Safety Products Canada Ltd. ("DSC"), the manufacturer of the integrated security systems and the developer of the software and any related products or components ("HARDWARE") which You acquired.
- If the DSC software product ("SOFTWARE PRODUCT" or "SOFTWARE") is intended to be accompanied by HARDWARE, and is NOT accompanied by new HARDWARE, You may not use, copy or install the SOFTWARE PRODUCT. The SOFTWARE PRODUCT includes computer software, and may include associated media, printed materials, and "online" or electronic documentation.
- Any software provided along with the SOFTWARE PRODUCT that is associated with a separate end-user license agreement is licensed to You under the terms of that license agreement.
- By installing, copying, downloading, storing, accessing or otherwise using the SOFTWARE PRODUCT, You agree unconditionally to be bound by the terms of this EULA, even if this EULA is deemed to be a modification of any previous arrangement or contract. If You do not agree to the terms of this EULA, DSC is unwilling to license the SOFTWARE PRODUCT to You, and You have no right to use it.

SOFTWARE PRODUCT LICENSE

The SOFTWARE PRODUCT is protected by copyright laws and international copyright treaties, as well as other intellectual property laws and treaties. The SOFTWARE PRODUCT is licensed, not sold.

1. GRANT OF LICENSE This EULA grants You the following rights:

- (a) Software Installation and Use - For each license You acquire, You may have only one copy of the SOFTWARE PRODUCT installed.
- (b) Storage/Network Use - The SOFTWARE PRODUCT may not be installed, accessed, displayed, run, shared or used concurrently on or from different computers, including a workstation, terminal or other digital electronic device ("Device"). In other words, if You have several workstations, You will have to acquire a license for each workstation where the SOFTWARE will be used.
- (c) Backup Copy - You may make back-up copies of the SOFTWARE PRODUCT, but You may only have one copy per license installed at any given time. You may use the back-up copy solely for archival purposes. Except as expressly provided in this EULA, You may not otherwise make copies of the SOFTWARE PRODUCT, including the printed materials accompanying the SOFTWARE.

2. DESCRIPTION OF OTHER RIGHTS AND LIMITATIONS

- (a) Limitations on Reverse Engineering, Decompilation and Disassembly - You may not reverse engineer, decompile, or disassemble the SOFTWARE PRODUCT, except and only to the extent that such activity is expressly permitted by applicable law notwithstanding this limitation. You may not make any changes or modifications to the Software, without the written permission of an officer of DSC. You may not remove any proprietary notices, marks or labels from the Software Product. You shall institute reasonable measures to ensure compliance with the terms and conditions of this EULA.

(b) Separation of Components - The SOFTWARE PRODUCT is licensed as a single product. Its component parts may not be separated for use on more than one HARDWARE unit.

(c) Single INTEGRATED PRODUCT - If You acquired this SOFTWARE with HARDWARE, then the SOFTWARE PRODUCT is licensed with the HARDWARE as a single integrated product. In this case, the SOFTWARE PRODUCT may only be used with the HARDWARE as set forth in this EULA.

(d) Rental - You may not rent, lease or lend the SOFTWARE PRODUCT. You may not make it available to others or post it on a server or web site.

(e) Software Product Transfer - You may transfer all of Your rights under this EULA only as part of a permanent sale or transfer of the HARDWARE, provided You retain no copies, You transfer all of the SOFTWARE PRODUCT (including all component parts, the media and printed materials, any upgrades and this EULA), and provided the recipient agrees to the terms of this EULA. If the SOFTWARE PRODUCT is an upgrade, any transfer must also include all prior versions of the SOFTWARE PRODUCT.

(f) Termination - Without prejudice to any other rights, DSC may terminate this EULA if You fail to comply with the terms and conditions of this EULA. In such event, You must destroy all copies of the SOFTWARE PRODUCT and all of its component parts.

(g) Trademarks - This EULA does not grant You any rights in connection with any trademarks or service marks of DSC or its suppliers.

3. COPYRIGHT - All title and intellectual property rights in and to the SOFTWARE PRODUCT (including but not limited to any images, photographs, and text incorporated into the SOFTWARE PRODUCT), the accompanying printed materials, and any copies of the SOFTWARE PRODUCT, are owned by DSC or its suppliers. You may not copy the printed materials accompanying the SOFTWARE PRODUCT. All title and intellectual property rights in and to the content which may be accessed through use of the SOFTWARE PRODUCT are the property of the respective content owner and may be protected by applicable copyright or other intellectual property laws and treaties. This EULA grants You no rights to use such content. All rights not expressly granted under this EULA are reserved by DSC and its suppliers.

4. EXPORT RESTRICTIONS - You agree that You will not export or re-export the SOFTWARE PRODUCT to any country, person, or entity subject to Canadian export restrictions.

5. CHOICE OF LAW - This Software License Agreement is governed by the laws of the Province of Ontario, Canada.

6. ARBITRATION - All disputes arising in connection with this Agreement shall be determined by final and binding arbitration in accordance with the Arbitration Act, and the parties agree to be bound by the arbitrator's decision. The place of arbitration shall be Toronto, Canada, and the installation manual of the arbitration shall be English.

7. LIMITED WARRANTY

(a) NO WARRANTY - DSC PROVIDES THE SOFTWARE "AS IS" WITHOUT WARRANTY. DSC DOES NOT WARRANT THAT THE SOFTWARE WILL MEET YOUR REQUIREMENTS OR THAT OPERATION OF THE SOFTWARE WILL BE UNINTERRUPTED OR ERROR-FREE.

(b) CHANGES IN OPERATING ENVIRONMENT - DSC shall not be responsible for problems caused by changes in the operating characteristics of the HARDWARE, or for problems in the interaction of the SOFTWARE PRODUCT with non-DSC-SOFTWARE or HARDWARE PRODUCTS.

(c) LIMITATION OF LIABILITY; WARRANTY REFLECTS ALLOCATION OF RISK - IN ANY EVENT, IF ANY STATUTE IMPLIES WARRANTIES OR CONDITIONS NOT STATED IN THIS LICENSE AGREEMENT, DSC'S ENTIRE LIABILITY UNDER ANY PROVISION OF THIS LICENSE AGREEMENT SHALL BE LIMITED TO THE GREATER OF THE AMOUNT ACTUALLY PAID BY YOU TO LICENSE THE SOFTWARE PRODUCT AND FIVE CANADIAN DOLLARS (CAD\$5.00). BECAUSE SOME JURISDICTIONS DO NOT ALLOW THE EXCLUSION OR LIMITATION OF LIABILITY FOR CONSEQUENTIAL OR INCIDENTAL DAMAGES, THE ABOVE LIMITATION MAY NOT APPLY TO YOU.

(d) DISCLAIMER OF WARRANTIES - THIS WARRANTY CONTAINS THE ENTIRE WARRANTY AND SHALL BE IN LIEU OF ANY AND ALL OTHER WARRANTIES, WHETHER EXPRESSED OR IMPLIED (INCLUDING ALL IMPLIED WARRANTIES OF MERCHANTABILITY OR FITNESS FOR A PARTICULAR PURPOSE) AND OF ALL OTHER OBLIGATIONS OR LIABILITIES ON THE PART OF DSC. DSC MAKES NO OTHER WARRANTIES. DSC NEITHER ASSUMES NOR AUTHORIZES ANY OTHER PERSON PURPORTING TO ACT ON ITS BEHALF TO MODIFY OR TO CHANGE THIS WARRANTY, NOR TO ASSUME FOR IT ANY OTHER WARRANTY OR LIABILITY CONCERNING THIS SOFTWARE PRODUCT.

(e) EXCLUSIVE REMEDY AND LIMITATION OF WARRANTY - UNDER NO CIRCUMSTANCES SHALL DSC BE LIABLE FOR ANY SPECIAL, INCIDENTAL, CONSEQUENTIAL OR INDIRECT DAMAGES BASED UPON BREACH OF WARRANTY, BREACH OF CONTRACT, NEGLIGENCE, STRICT LIABILITY, OR ANY OTHER LEGAL THEORY. SUCH DAMAGES INCLUDE, BUT ARE NOT LIMITED TO, LOSS OF PROFITS, LOSS OF THE SOFTWARE PRODUCT OR ANY ASSOCIATED EQUIPMENT, COST OF CAPITAL, COST OF SUBSTITUTE OR REPLACEMENT EQUIPMENT, FACILITIES OR SERVICES, DOWN TIME, PURCHASERS TIME, THE CLAIMS OF THIRD PARTIES, INCLUDING CUSTOMERS, AND INJURY TO PROPERTY.

WARNING: DSC recommends that the entire system be completely tested on a regular basis. However, despite frequent testing, and due to, but not limited to, criminal tampering or electrical disruption, it is possible for this SOFTWARE PRODUCT to fail to perform as expected.

Locating Detectors and Escape Plan

The following information is for general guidance only and it is recommended that local fire codes and regulations be consulted when locating and installing smoke and CO alarms.

Smoke Detectors

Research has shown that all hostile fires in homes generate smoke to a greater or lesser extent. Experiments with typical fires in homes indicate that detectable quantities of smoke precede detectable levels of heat in most cases. For these reasons, smoke alarms should be installed outside of each sleeping area and on each storey of the home.

The following information is for general guidance only and it is recommended that local fire codes and regulations be consulted when locating and installing smoke alarms.

It is recommended that additional smoke alarms beyond those required for minimum protection be installed. Additional areas that should be protected include: the basement; bedrooms, especially where smokers sleep; dining rooms; furnace and utility rooms; and any hallways not protected by the required units. On smooth ceilings, detectors may be spaced 9.1m (30 feet) apart as a guide. Other spacing may be required depending on ceiling height, air movement, the presence of joists, uninsulated ceilings, etc. Consult National Fire Alarm Code NFPA 72, CAN/ULC-S553-02 or other appropriate national standards for installation recommendations.

- Do not locate smoke detectors at the top of peaked or gabled ceilings; the dead air space in these locations may prevent the unit from detecting smoke.
- Avoid areas with turbulent air flow, such as near doors, fans or windows. Rapid air movement around the detector may prevent smoke from entering the unit.
- Do not locate detectors in areas of high humidity.
- Do not locate detectors in areas where the temperature rises above 38°C (100°F) or falls below 5°C (41°F).
- Smoke detectors should always be installed in USA in accordance with Chapter 11 of NFPA 72, the National Fire Alarm Code: 11.5.1.1.

Where required by applicable laws, codes, or standards for a specific type of occupancy, approved single- and multiple-station smoke alarms shall be installed as follows:

1. In all sleeping rooms and guest rooms.
2. Outside of each separate dwelling unit sleeping area, within 6.4 m (21 ft) of any door to a sleeping room, the distance measured along a path of travel.
3. On every level of a dwelling unit, including basements.
4. On every level of a residential board and care occupancy (small facility), including basements and excluding crawl spaces and unfinished attics.
5. In the living area(s) of a guest suite.
6. In the living area(s) of a residential board and care occupancy (small facility).

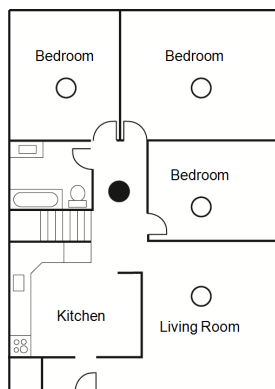

Figure 1

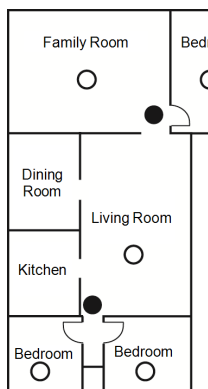

Figure 2

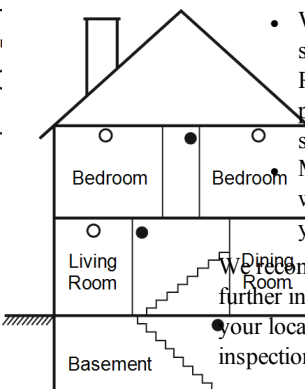

Figure 3

- Write the fire escape plan down and rehearse it frequently so that should an emergency arise, everyone will know what to do. Revise the plan as conditions change, such as the number of people in the home, or if there are changes to the building's construction.
- Make sure your fire warning system is operational by conducting weekly tests. If you are unsure about system operation, contact your installer.
- We recommend that you contact your local fire department and request further information on fire safety and escape planning. If available, have your local fire prevention officer conduct an in-house fire safety inspection.

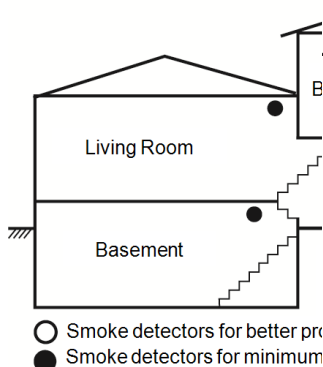

Figure 3a

Fire Escape Planning

There is often very little time between the detection of a fire and the time it becomes deadly. It is thus very important that a family escape plan be developed and rehearsed.

1. Every family member should participate in developing the escape plan.

Study the possible escape routes from each location within the house. Since many fires occur at night, special attention should be given to the escape routes from sleeping quarters.

Escape from a bedroom must be possible without opening the interior door.

Consider the following when making your escape plans:

- Make sure that all border doors and windows are easily opened. Ensure that they are not painted shut, and that their locking mechanisms operate smoothly.
- If opening or using the exit is too difficult for children, the elderly or handicapped, plans for rescue should be developed. This includes making sure that those who are to perform the rescue can promptly hear the fire warning signal.
- If the exit is above the ground level, an approved fire ladder or rope should be provided as well as training in its use.
- Exits on the ground level should be kept clear. Be sure to remove snow from exterior patio doors in winter; outdoor furniture or equipment should not block exits.
- Each person should know the predetermined assembly point where everyone can be accounted for (e.g., across the street or at a neighbor's house). Once everyone is out of the building, call the fire department.
- A good plan emphasizes quick escape. Do not investigate or attempt to fight the fire, and do not gather belongings as this can waste valuable time. Once outside, do not re-enter the house. Wait for the fire department.

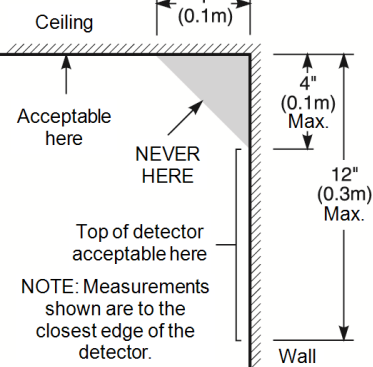

Figure 4

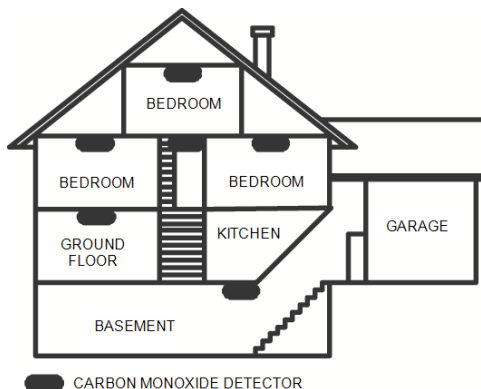

Figure 5

Carbon Monoxide Detectors

Carbon monoxide is colorless, odorless, tasteless, and very toxic, it also moves freely in the air. CO detectors can measure the concentration and sound a loud alarm before a potentially harmful level is reached. The human body is most vulnerable to the effects of CO gas during sleeping hours; therefore, CO detectors should be located in or as near as possible to sleeping areas of the home. For maximum protection, a CO alarm should be located outside primary sleeping areas or on each level of your home. Figure 5 indicates the suggested locations in the home.

Do NOT place the CO alarm in the following areas:

- Where the temperature may drop below -10°C or exceed 40°C
- Near paint thinner fumes
- Within 5 feet (1.5m) of open flame appliances such as furnaces, stoves and fireplaces
- In exhaust streams from gas engines, vents, flues or chimneys
- Do not place in close proximity to an automobile exhaust pipe; this will damage the detector

PLEASE REFER TO THE CO DETECTOR INSTALLATION AND OPERATING INSTRUCTION SHEET FOR SAFETY INSTRUCTIONS AND EMERGENCY INFORMATION.

SIA False Alarm Reduction Installations: Quick Reference

Minimum required system consists of one Control unit model HS2128 or HS2064 or HS2032 or HS2016 and any one of the compatible listed keypads: HS2LCDRF9, HS2LCDRFP9, HS2ICNRF9, HS2ICNRF9P, HS2LCD, HS2LCDP, HS2ICN, HS2ICNP, HS2LED HS2TCHP.

The following wireless keys can also be used in SIA compatible installations: PG9929, PG9939, PG9949.

Note: For models PG9929 and PG9939, the panic/emergency key shall be disabled for SIA compliant installations.

For a list of the default values programmed when the unit is shipped from the factory, and for any other programming information, refer to the following table.

The following optional subassembly modules also bear the SIA CP-01-2010 classification and may be used if desired: HSM2108 zone expander, HSM2208 PGM output module, HSM2300 auxiliary power supply, HSM2204 output module, HSM2HOST9 2-way wireless transceiver, PG9901 indoor siren, PG9911 outdoor siren, and 3G2080(R)/ TL2803G (R)/ TL280(R) cellular and PSDN communication module.

Caution

- For SIA FAR installations use only modules/devices that are listed on this page.
- Fire Alarm Verification feature (Auto Verified Fire Zone type [025]) is not supported on 2-wire smoke detectors zones, model FSA-210B(T)(S)(ST)(LST)(R)(RT)(RD)(RST)(LRST). This feature may be enabled for 4-wire smoke detectors only (FSA-410B (T)(S)(ST)(LST)(R)(RT)(RST)(LRST) and wireless detectors PG9916/PG9926). The fire alarm delay is 60s.
- Call Waiting Cancel (Section [382], Option 4) feature on a non-Call Waiting line will prevent successful communication to the supervising station.
- All smoke detectors on the system must be tested annually by conducting the Installer Walk Test. Prior to exiting walk test mode, a sensor reset must be done on the system, [*][7][2], to reset all latching 4-wire smoke detectors. Refer to the installation instructions supplied with the detector for details.

Notes

- Programming at installation may be subordinate to other UL requirements for the intended application.
- Cross zones have the ability to individually protect the intended area (e.g. motion detectors which overlap).
- Cross zoning is not recommended for line security Installations nor is it to be implemented on exit/entry zones.
- This control panel has a communication delay of 30 seconds. It can be removed or increased up to 45 seconds by the end user in consultation with the installer.
- The security system shall be installed with the sounding device activated and the communicator enabled for transmission using SIA or CID format.
- ULC commercial burglary installations require DEOL resistors.

| SIA Feature Programming Section | Comments | Range/Default | Requirement |
|---|---|---|----------------------------|
| Exit Time [005]>[001], option 3 | Access to Entry and Exit delays and Bell Time Out for the system. | Range:45- 255 seconds Default: 60 sec. | Required (programmable) |
| Exit Delay Restart [018], option 7 | Opening a Delay zone door after it has already been opened and closed during an exit delay restarts the exit delay timer. | Default: Enabled | Required |
| Auto Stay Arm on Un-vacated Premises [001]>[001]-[128] Zone type 05, 06,09 | Function key: Forces the system to arm in Stay mode if the occupant does not exit the premises after pressing the Away function key. | If no exit after full arm Default: Enabled | Required |
| Exit Time and Progress Annunciation/Disable or Remote Arming [861]>[001]-[005], option 4 | System times and audible exit beeps can be disabled when using the wireless key to stay arm the system. When away arming, audible exit beeps can not be disabled. | Default: Enabled | Allowed |
| Entry delay(s) [005]>[001]-[008], options 1 and 2 | Access to entry and exit delays and bell time out for the system Note: Combined entry delay and communications delay (abort window) shall not exceed 60s. | Range: 30 sec. to 4 min. Default: 30 sec. | Required (programmable) |
| Abort Window for Non-Fire zones [002]>[001]-[128], option 7 ON | Access to zone attributes, i.e., swinger shutdown, transmission delay and cross zone. May be disabled by zone or zone type. | Default: Enabled | Required |
| Abort Window Time - for Non-Fire zones [377]>[002], option 1 | Access to the programmable delay before communicating alarms Note: Combined entry delay and communications delay (abort window) shall not exceed 60 seconds. | Range: 00 - 45 sec. Default: 30 sees | Required (programmable) |
| Abort Annunciation | An audible tone is generated when an alarm is aborted during the abort window. | Hard-coded ON | Required |
| Duress Feature [*][5]> master code> user 2-95> 5> 2 | When this feature is enabled, selected user codes send a duress reporting code to the central station when used to perform any function on the system. Section [019], option [6] must be enabled. | Default: N | Required |
| Cancel Window [377]>[002], option 6 | Access to the communications cancel window. Minimum duration must be 5 minutes. | Range: 005-255 Default: 005 | |
| Cancel Annunciation [308]>[001], option 8 | Access to the reporting code for Alarm Canceled. | A Cancel was transmitted Default: Enabled | Required |
| Cross Zoning [042]>Selection 3, option 002 | Enables cross zoning for entire system. Zones can be enabled for cross zoning via zone attribute option 8 in sections [002][101] - [128]. | Programming required Default: Disabled | Required |
| Burglary Verification Timer [005]>[000], option 3 | Access to the programmable Cross Zone timer. | Range: 000-255 sec. Default: 60 seconds | Allowed |
| Swinger Shutdown for Alarms [377]>[001], option 1 | Access to the swinger shutdown limit for zone alarms For all non-fire zones, shut down at 1 to 6 trips. | Default: 2 trips | Required (programmable) |
| Swinger Shutdown Enable [002]>[001] - [128], option 6 ON | Access to swinger shutdown, transmission delay and cross zone attributes. Zone attribute option 6 (Swinger Shutdown enabled) is ON. | Non-police response zones Default: Enabled | Allowed |
| 24-Hr. Auto-verified Fire [001]>[001]-[128], Zone type 025 ON | Access to 24-Hr. Auto-verified Fire Activates if Not restored within the specified time. | Must choose zone type for application | Required |
| Call Waiting Cancel [382], option 4 OFF | Access to the dialing sequence used to disable call waiting. Call waiting string can be programmed in [304] | Depends on user phone line Default: Disabled | Required |
| System Test: [*][6] Master Code, option 04 | The system activates all keypad sounders, bells or sirens for 2 seconds and all keypad lights turn on. Refer to user manual (part no. 29008365). | | |
| Walk Test Mode: [*][8][Installer code][901] | This mode is used to test each zone on the system for proper functionality. | | |
| Walk Test Communications [382], option 2 | Enables communication of zone alarms while walk test is active. | Default: Disabled | |
| Walk Test Start/ End Reporting Codes [308][401], options 1 and 2 | Access to the reporting codes for walk test start and end times. | | |

The trademarks, logos, and service marks displayed on this document are registered in the United States [or other countries]. Any misuse of the trademarks is strictly prohibited and Tyco will aggressively enforce its intellectual property rights to the fullest extent of the law, including pursuit of criminal prosecution wherever necessary. All trademarks not owned by Tyco are the property of their respective owners, and are used with permission or allowed under applicable laws.

Product offerings and specifications are subject to change without notice. Actual products may vary from photos. Not all products include all features. Availability varies by region; contact your sales representative.

DSC

From Tyco Security Products

© 2015 Tyco Security Products
All Rights Reserved.
Tech Support: 1-800-387-3630 (Canada & U.S.)
or 905-760-3000
www.dsc.com

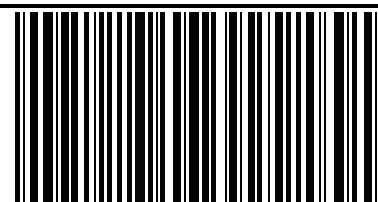

29009043 R002